

Publish Date: April 2024
EVPT200DV20214 Rev. 2
USA/North America
©Everlast Power Equipment

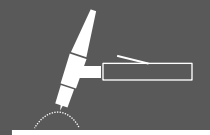

**AC/DC
PULSE**

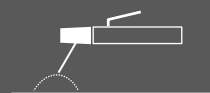

DC

PowerTIG 200DV

Safety, Setup and General Use Guide



FUNCTION: AC/DC TIG with Pulse Function/ DC Stick
PURCHASE DATE:
WELDER SERIAL NUMBER:
OPTIONAL ACCESSORY SERIAL NUMBER:

**120/240V
1 Phase**

Operator's Manual



Welders, Plasma Cutters, Multi-Process

www.everlastwelders.com
Need Parts? Need Technical Help? Call: 1-877-755-9353

380 Swift Ave. Unit 12 South San Francisco, CA 94080, USA

TABLE OF CONTENTS

SPECIAL NOTICE AND CALIFORNIA PROPOSITION 65 WARNING	3
CUSTOMER GREETING AND EXPLANATION OF PROCEDURES	4
WARRANTY AND CONTACT INFORMATION	5
SAFETY DISCLAIMER AND HF WARNING	6
SAFETY WARNINGS, DANGERS, CAUTIONS AND INSTRUCTIONS	7
GENERATOR OPERATION INFORMATION	10
SPECIFICATIONS, INCLUDING DUTY CYCLE AND INPUT AMPERAGE INFORMATION	11
GETTING STARTED, UNPACKING YOUR UNIT AND INSPECTION	12
CONNECTING YOUR UNIT TO THE POWER SOURCE AND WIRING INFORMATION	13
SHIELDING GAS INFORMATION AND CONNECTION OF REGULATOR	14
TUNGSEN SELECTION AND GRINDING	15
CONNECTING YOUR UNIT AND READYING TO WELD (POLARITY AND PANEL CONNECTIONS)	18
GENERAL SETTINGS AND INFORMATION	20
FRONT PANEL VIEW AND COMPONENT ID	21
REAR PANEL VIEW AND COMPONENT ID	22
CONTROL PANEL LAYOUT AND ID OF FEATURES	23
TORCH PARTS AND ASSEMBLY	30
7 PIN CONNECTOR PINOUT AND INFORMATION	31
TROUBLESHOOTING ERROR CODES	32
TROUBLESHOOTING COMMON ISSUES	33
MAINTENANCE	34

NOTICE:

Product Specifications and features are subject to change without notice. While every attempt has been made to provide the most accurate and current information possible at the time of publication, this manual is intended to be a general guide and not intended to be exhaustive in its content regarding safety, welding, or the operation/maintenance of this unit. Due to multiple variables that exist in the welding field and the changing nature of it and of the Everlast product line, Everlast Power Equipment INC. does not guarantee the accuracy, completeness, authority or authenticity of the information contained within this manual or of any information offered during the course of conversation or business by any Everlast employee or subsidiary. The owner of this product assumes all liability for its use and maintenance. Everlast Power Equipment INC. does not warrant this product or this document for fitness for any particular purpose, for performance/accuracy or for suitability of application. Furthermore, Everlast Power Equipment INC. does not accept liability for injury or damages, consequential or incidental, resulting from the use of this product or resulting from the content found in this document or accept claims by a third party of such liability.

WARNING!

California Proposition 65 Warning:

This product, when used for welding or cutting, produces fumes or gases which contain chemicals known to the State of California to cause birth defects and, in some cases, cancer. (California Health & Safety Code § 25249.5 et seq.)

 Warning: Cancer and/or Reproductive Harm

www.P65warnings.ca.gov

THANK YOU! We appreciate you as a valued customer and hope that you will enjoy years of use from your welder. We work to please the customer by providing a well supported, quality product. ***To make sure that you receive the best quality ownership experience, please see below for important information and time sensitive details.***

What to do right now:

1. Print your receipt from your confirmation email that should have been sent to you after your purchase and put it up for safe keeping. If you do not have one, contact us at 1-877-755-9353 (US customers) or 1-905-570-1818 (Canadian Customers). You will need this if anything should ever happen for original owner verification (if bought as a gift, original receipt will still be needed, or explanation sent to Everlast).
2. Read this manual! A large number of tech and service calls are a result of not reading the manual from start to finish. Do not just scan or casually peruse this manual. There are different features and functions that you may not be familiar with, or that may operate differently than you expect. Even if you have expertise in the field of welding, you should not assume this unit operates like other brands or models you have used.
3. Carefully unpack and inspect all items immediately. Look for missing or damaged items. Please report any issues within 48 hours (72 hours on weekend or holidays) of receiving your product,. Take pictures if you are able and contact us at 1-877-755-9353, ext. 207 if any issue is discovered between 9 am and 5 pm Eastern Time M-F (US customers) or at 1-905-570-1818 (Canadian Customers) between 9am and 4 pm weekdays except on Fridays when hours are from 9 am to 12pm Eastern. If outside of the US or Canada, contact your in-country/or regional distributor direct at their service number.

What to do within the next 2-3 days:

1. Make sure your electrical system is up to date and capable of handling the inrush and rated current of the unit. Consult and use a licensed and knowledgeable electrician. If you have downloaded this manual in expectation of delivery, get started now.
2. Make sure this machine is plugged in, turned on, and tested with every process and major feature, checking for proper function. You have a 30 day period to test and thoroughly check out the operation of this unit under our 30 day satisfaction period. If something is wrong, this policy covers shipping on the unit (30 day satisfaction policy applies to the USA only for the 48 lower states and D.C., territories and provinces are excluded) or any incidental parts that may be needed to resolve any issue. After this 30 day period, if you find something wrong with the unit, you will not receive the benefit of free shipping back and forth to resolve this issue. Your unit is still covered under the 5 year parts/labor warranty, but shipping is covered by the customer after the 30 day period is over. The first 30 days of operation with any electronic item is the most critical and if any issue will happen, it will often happen during this time. This is why it is very important that you put this unit to work as soon as possible. Any issue should be reported within 48 hours (72 if on the weekend or holiday). Everlast will not be liable for any shipping after that time.

What to do within the next 30 days:

Visit our website (US customers). Go to www.everlastwelders.com. Navigate to the resources tab and to the “product registration” page to register your product. While keeping your receipt/proof of purchase is still required for verification of ownership, registering will help us keep your details straight and establish a chain of ownership. Don't worry, though, your warranty is still valid if you can't do this. Remember: Always keep your receipt even if you register. You may want to staple a copy to your manual.

What to do if you have a warranty issue or problem with the unit:

1. Unplug the unit. (Also do this before any maintenance or cleaning is done.)
2. Do not attempt a self-repair until authorized by an Everlast representative. This does not include performing routine maintenance such as regular internal cleaning. Any third party repairs are not covered under warranty, and can further damage your unit.
3. Within 24-48hours, (or by the next working business day) you must contact U.S. tech support at 1-877-755-9353 ext 207(U.S. hours are 9 am to 5pm Eastern for tech support and 9 am to 5 pm Pacific for the business/sales office). If you are in Canada contact 1-905-570-1818 (Canada hours are 9am to 4pm M-Th, 9am to 12pm Fri). Although phone contact is preferred to establish a warranty claim, you may send an email to tech@everlastwelders.com (US) or mike@everlastwelders.ca (Canada) along with your contact information and brief explanation of the issue and ask for a follow up call. If you contact us via phone, and you do not reach a live person, please leave a brief message with the nature of your problem and your contact information. You should expect a call back within 24 hours. It is also a good idea to follow up the message with an email.
4. Be prepared with as much information as possible when you talk with a tech advisor, including a details of the failure, settings, and application of the unit. ***NOTE: A Proof-Of-Purchase (receipt) is required before returning the unit for warranty or before warranty parts can be sent to you.***
5. Keep in mind that, you may be asked to check a few basic things. Before you call, having a screwdriver and volt/ohm meter at hand is a good idea and will save time. Many issues can be resolved over the phone. If the issue cannot be resolved over the phone/email, you may be given an option to return the unit, or have a part shipped to you, at Everlast's discretion. Keep in mind, you may be asked questions that seem basic, or elementary to your knowledge base. These are not meant to question your knowledge, but rather to make sure nothing is overlooked. However the tech chooses to proceed, please cooperate with the process, even if you think you know what the cause or issue is. You may be asked to check something or open the unit during the diagnosis. This does not void the warranty! Opening the unit is a part of routine maintenance and cleaning. This is an important step. The willingness of the customer to work with tech support can save lots of time and accelerate the warranty process. For

warranty to be honored, you will need to make sure that you follow these guidelines. *Units that are returned without an RMA (issued by the tech support department) may not be repaired under the warranty agreement and you may be charged for the repair and can result in a delayed repair as well.*

What to do if you need setup help, guidance, weld issue diagnosis or have general product compatibility questions.

Call us at 877-755-9353 ext. 204 for welding guidance and general welding issue diagnosis. Or email performance@everlastwelders.com with the basic issue you are having, along with your specific settings, and welding application.

Hey...wait, what is my warranty?

Warranties and service policies and procedures vary from country to country and are maintained and supported by the regional or in country distributor of Everlast welding equipment.

USA Customers Only: For full details on the 5 year parts and labor warranty, 30 day satisfaction policy, terms of sale, and how to proceed with a warranty claim, please visit: <https://www.everlastgenerators.com/standard-warranty>. Accessories are covered by a separate warranty and detailed information can also be found at the link above.

Canada Customers Only: For full details on the 3 year parts and labor warranty, terms of sale, and related policies and procedures, please visit: <https://www.everlastwelders.ca/terms.php>.

Who do I contact?

USA Technical Support:

Email: tech@everlastwelders.com
1-877-755-9353 ext. 207
9am-5pm Eastern (Closed holidays)
Monday-Friday

USA Welding Support and General Product Information:

Email: performance@everlastwelders.com
1-877-755-9353 ext 204
9am-6:30 pm Eastern (Closed holidays)
Monday-Friday

USA Sales and Main Office:

Email: sales@everlastwelders.com
1-877-755-9353 ext 201
9am-5pm Pacific (Closed holidays)
Monday-Friday

Canada Technical Support:

Email: mike@everlastwelders.ca
905-570-1818
9am-4pm Eastern Monday-Thursday
9am-12pm Eastern Friday

Canada Sales and Main Office:

Email: sales@everlastwelders.ca
905-570-1818
9am-4pm Eastern Monday-Thursday
9am-12pm Eastern Friday

Other Countries and Regions:

Visit the U.S. Website @ www.everlastwelders.com and click on the flag of the country or region represented that is closest to you. If your country or region is not found, call the U.S. office at 1-650-588-8588 between the hours of 9am to 5pm Pacific, Monday through Friday.



Safe operation and proper maintenance is your responsibility.

Everlast is dedicated to keeping safety a top priority. While we have compiled this operator's manual to instruct you in basic safe operation and maintenance of your Everlast product, it is no substitute for observing safe welding practices and behavior. Safe welding and related cutting operations require basic knowledge, experience and ultimately the exercise of common sense. **Welding does significant hazards to your health and life! Exercise extreme caution and care in all activities related to welding or cutting. Your safety, health and even life depends upon it.**

WARNING! If you do not have proper knowledge or capability to safely operate this machine, do not use this machine until proper training has been received!

While accidents are never planned, preventing an accident requires careful planning. Stay alert!

Please carefully read this manual before you operate your Everlast unit.

The warranty does not cover damage or harm created by improper use, neglect of the machine or failure to follow safe operating practices.

NOTICE:



Welding and cutting operations may generate undesirable High Frequency (HF) and EMF energy. This can interfere with surrounding electronic equipment such as computers, routers, CNC equipment, televisions, radios, fluorescent lighting etc. If disturbance in surrounding electrical and electronic equipment is noted, consult a licensed electrician to help properly ground surrounding equipment to limit the interference. This machine may cause GCFI and ground fault outlets to malfunction. This unit is designed to be operated on a dedicated, properly grounded circuit.

Safety Warnings, Dangers, Cautions and Instructions



NOTICE. This unit manual is intended for users with basic knowledge and skillset in welding. It is your responsibility to make certain that the use of this welder is restricted to persons who have read, understand and follow the warnings and instructions in this manual. If you or the operator needs further instruction, contact Everlast welding support at 1-877 755-9353 ext. 204 or seek qualified professional advice and training.



WARNING! High Frequency (HF) energy and the welding volt/amps used can interfere with the operation of pacemakers and can damage pacemakers. Consult with your physician and pacemaker manufacturer *before* entering an area where welding and cutting equipment is in operation and *before* using this welder. Some pacemakers have limited shielding. Alert any users or customers of this potential problem.



WARNING! Use approved safety glasses with wrap around shields and sides while welding and working in the weld area or serious eye damage or loss of vision may result. Use a grinding shield in addition to the safety glasses during chipping and grinding operations.



WARNING! When welding always use an approved welding helmet or shielding device equipped with at least an equivalent of a shade 9 or greater. Increase the shade number rating as amperage increase over 100 amps. Inspect helmet for cracks in lenses and in the helmet. Keep lens covers in good condition and replace as necessary.



WARNING! Welding/cutting operations carry inherent risks which include but not limited to possible cuts burns, electrical shocks, lung damage, eye damage and even death. Take all appropriate measures to use proper Personal Protective Equipment (PPE). Always use leather welding gloves, closed toe (preferably reinforced or steel toe leather shoes, and long-sleeved flame resistant clothing (i.e. denim). Do not wear Poly/Nylon blend materials.



DANGER! Welding poses shock and electrocution risks. Keep this welding equipment dry. **Do not weld in the rain or where moisture accumulates.** Use dry, rubber soled shoes, gloves and clothing when welding. Do not rest or contact work clamp (ground) when welding. Keep all parts of the body insulated from the part being welded when possible. Do not touch both terminals or connections at the same time. Consider all welder parts to be “live” at all times even if no welding is being performed. Do not use frayed welding cables.



CAUTION! Fires are possible but also preventable while welding. Always remove flammable rags, papers, and other materials from the weld area. Keep rags stored in an approved flame proof canister. Keep a fully charged fire extinguisher at hand. Remove any fuels, oils, paint, pressurized spray cans, and chemicals from the weld area. Make sure any smoke/fire detectors are function properly. Do not weld on tanks, drums or barrels, especially if pressurized or sealed. Do not weld on any container that previously held fuel or chemicals. Make sure the weld area is clear of flammable materials such as grass or wood shavings solvents and fuels. Do not wear frayed or loose clothing. Visually inspect and recheck the work area after welding looking for smoldering debris or flames.

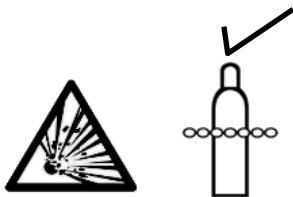

WARNING! Welding gas cylinders are under high pressure. Keep all gas cylinders upright and chained to a cart or held safely in a safety holding pen. Never transport gas cylinders in an enclosed car van or other vehicle. Transport gas cylinders securely. Keep all cylinders capped while not in use or during transport. Replace the cap on the cylinder when it is going to be more than 24 hours before use. Do not use or attempt to repair faulty regulators. Never weld on gas cylinders. Keep gas cylinders away from direct sparks.

Safety Warnings, Dangers, Cautions and Instructions



DANGER! Welding and cutting operations pose serious inhalation hazards. Some of these hazards are immediate while others are cumulative in their effect. **Do not weld in enclosed spaces or in areas without adequate ventilation.** Fumes and gases released in the welding and cutting operations can be toxic. Use fans or respiration equipment to insure adequate ventilation if you are welding in a shop or garage area. **Do not weld on galvanized metal under any circumstance. You may develop metal fume fever. Symptoms are similar to lu-like symptoms. Seek medical advice and treatment if you are exposed to galvanized welding fumes.**

If you experience any eye burning, nose or throat irritation while welding, these are signs that you need more ventilation.

If you feel these symptoms:

- Stop work immediately and relocate work area with better ventilation.
- Wash and clean your face and hands.
- Stop work completely and seek medical help if irritation persists



DANGER! Never use brake cleaner or any chlorinated solvent to clean or degrease metal scheduled to be welded or other related equipment in the area being welded. The heating of this cleaner and its residue will create highly toxic phosgene gas. Small amounts of this vapor are harmful and can lead to organ failure and death. If degreasing of a part is necessary, use Acetone or an approved pre-weld cleaner. Use the proper personal protective equipment (PPE) when handling any cleaners/solvents.







DANGER! People with pacemakers should consult a physician and pacemaker manufacturer before welding. There is a potential for damage or serious malfunction resulting in death. High Frequency energy (HF)/Electromagnetic Fields generated during welding can interfere with pacemaker signals, even permanently damaging it. Some pacemakers offer some shielding, but restrictions regarding amperage and HF starting of TIG arcs may be placed upon the individual. Warn all potential bystanders that they should exit the work area if they have a pacemaker or similar medical equipment before welding. Consult with a Physician if a pacemaker is expected to be implanted.



DANGER! Never defeat or modify any safety guards or shields. Keep all safety covers and shields in place.

Never place your fingers in or near a fan shroud or insert any object into the fan(s).

Safety Warnings, Dangers, Cautions and Instructions

	<p>CAUTION! Trip Hazards exist around welders. Cords, cables, welding leads and hoses pose a trip hazard. Be aware of their location and inform others of their location. Tape and secure them so they will stay out of high traffic areas.</p>
	<p>CAUTION! Welded metal can stay hot long after welding is completed. Burns may occur. Always wear gloves or use tongs/pliers when handling welded or cut metal. Remember the heat from the metal may catch other material on fire. Always have a fire-proof area ready to place welded components until they fully cool. Use soap stone or a metal marking marker to label the metal as “HOT” to serve as a reminder to all present in the area.</p>
	<p>CAUTION! Welding and cutting operations generate high levels of ultraviolet (UV) radiation which can burn and damage skin and eyes. The intensity is so high that exposed skin and eyes can burn in a few minutes of exposure. Minimize direct skin and eye exposure to this intense form of radiation by using proper PPE and sun screen where appropriate.</p>
	<p>CAUTION! Do not allow bystanders. Do not allow others without proper Personal Protection Equipment (PPE) suitable for welding to stand in the welding area or to observe welding and welding related activities. If protection is not readily available, use a welding screen to separate the welding area from the rest of the area. If no protection or screen is available, physically exclude them from the welding area by a wall or other solid divider. Keep all pets and young children away from the welding area.</p>
	<p>CAUTION! Electromagnetic Fields can be generated by this welder and radiate into the work place. The effect of EMF is not fully known. Exercise caution when welding by: NOT draping welding leads (guns/cables) over your shoulders or arms, NOT coiling them around your body, NOT inserting yourself directly between the cables, and by NOT contacting the unit while welding. DO keep the work clamp connected as close as possible to the area of the weld and directly to the object being welded whenever possible.</p>

Important Information: Operating this unit with a generator or other off-grid service.

This welder should only be operated on a generator certified by its manufacturer to produce clean power. Clean power is equivalent to the quality of household or shop/garage type power. This means the generator must have 5% or less total harmonic distortion (THD) of the Sine wave. If you are unsure of the power output type of the generator, contact the manufacturer of the generator for verification. *Do not operate on square wave or modified square wave generators or converters/inverters or damage or malfunction may occur. Damage caused by running this welder off of "dirty" power or modified sine waves may not be readily apparent and can be cumulative in nature. However, damage may present itself immediately. The damage caused by running this welder on "dirty" power usually leaves internal tell-tale signs and damages specific parts.*

When operating on 240V 1 phase, you will need a minimum of 9000 surge Watts. Ideally, it is recommended for use with 11,000 watt generators or larger. Operating the unit on under-powered generators and/or on generators not rated with 5% or less THD can damage your unit. *The generator manufacturer determines this rating, not Everlast.* Do not assume that a name brand generator, or a "new" generator automatically provides clean power. Price paid does not guarantee a clean power output either. There are multiple brands at various price points capable of producing clean power. Investigate this before purchasing a generator. The manufacturer will usually state that a unit is clean power in the advertising information and will state actual THD. If the manufacturer does not state it, contact the manufacturer directly for actual THD.

NOTICE! Operation of this unit with generators not rated by its manufacturer as providing clean power (5% or less THD) is prohibited and will void the warranty. Operation with modified sine wave, or square wave generators and inverters/converters/UPS that do not produce "sine wave" output is prohibited and doing so will also void the warranty. Use only with generators/inverters/converters that produce an equivalent type of sine wave used in shops, homes and "shore" type systems.

WARNING! Do not start or stop the generator with the welder switched on. Never use the generator in ECO mode or an auto-idle mode. Even with a clean power rated generator, this action can damage the unit. *Turn on the welder only after full generator R.P.M. has been achieved and the engine is sufficiently warmed up.* Closely monitor generator fuel level so that the engine R.P.M doesn't drop or completely shut down with the welder plugged in. **For best practice: do not start or stop the generator with this welder plugged in, even if it is turned off. Unplug the welder before shutting down the generator.**

If using with a welder generator, make sure the manufacturer has determined that the generator portion produces a clean sine wave. Many older models do not. Some newer models use "divided" power between welding and generating and cannot supply the full power to the welder unless the fine current control knob is turned to maximum. Do not use this unit with such welder/generators unless the Power/fine current control is turned to 100%. Some welder generators do have a separate alternator for generating power. If this is the case, just be sure not to weld or load the machine while this unit is in use.

WARNING! Always make sure any generator or welder generator is properly grounded, according to local code. Ground the machine per the generator manufacturers instructions to meet code. Improperly grounded generators may damage the machine and more importantly may cause severe injury or death.

Single Phase 120/240V Operation:

This unit may be used with single phase 120V to 240V output. Output and duty cycle should not be greatly affected. Please note that 208V one phase power is permissible only if the current does not drop below 205V under load. Usually, this does not become a concern unless it is being used in older installations or if the unit is operated at some distance from the power source, or conductors are too small for the distance.

Operating this unit on an extension cord while on 208V may reduce voltage to the machine if it is improperly sized or too long and can cause IGBT or PCB failure if power drops below 205V under load.

120V, 220V, 230V and 240V installation on single power should present no issues if codes are followed and proper sized conductors are used. On 120V, the power output is reduced. Use the 240V to 120V pigtail adapter supplied to adapt for 120V operation. No internal changeover is required. The unit automatically senses the voltage changeover and recalibrates output.

Specifications

Duty Cycle

Duty Cycle is simply the amount of time out of a 10 minute period in which the unit can operate. For example, if this unit has a duty cycle of 60%, that means that the unit can be operated for 6 minutes out of 10 minutes. This may be continuously, or intermittently during the 10 minute period of time. This rating standard (United States) is based on a maximum ambient temperature of 40°C. Operating above this point, or at lower temperatures with high humidity may reduce the duty cycle rating. Of course, the duty cycle may increase somewhat as ambient temperature drops. Regardless, this unit's duty cycle is not controlled by a timer. Rather, this unit is equipped with a heat sensor located on a heat sink near the critical power components of the welder. If the operating temperature of the unit is exceeded, welding output will stop and an over-temperature warning light/error code will be displayed on the panel. **If a duty cycle event is registered, do not turn the unit off!** Allow the welder to continue to run without welding for at least 10-15 minutes until the temperature has fallen enough to reset the over-temperature warning light and fan shut down. ***The cooling fan, if triggered by the temperature sensor, must continue to run to cool the unit properly after the duty cycle shut down has occurred.*** If the fan is not running after use, or shut down automatically the unit is safe to shut off without further cool down. However, do not shut down the unit until the fan turns off.

The intentional and/or repeated triggering of the duty cycle protection feature on this unit will shorten the lifespan of the unit's electronics and can weaken internal components. The effect of overheating your unit repeatedly takes a cumulative, long term toll on the unit.

Breaker Sizing and Wiring Requirements

Before installation of this unit in any facility, always consult a licensed local electrician familiar with the requirements of properly wiring a welder into the electrical supply. Refer to the National Electric Code (NEC) and local codes. If needed, refer the electrician to Article 630 of the NEC during consultation to determine proper application and wiring needs. Use the I1MAX and the I1EFF ratings listed above to determine the proper breaker and conductor (wire) sizing required. Everlast welders are designed around use in industrial wiring applications and are intended to be used with modern electrical systems. Household wiring may need to be upgraded before this welder may be installed. Additional protection and isolation may be needed if this welder interferes with the operation of electrical/electronic equipment. **WARNING!** Do not modify welder wiring. This unit meets the standards for conductor sizing on the power cable and takes into account power cable length, duty cycle and rated current.

Specifications

Product Specifications

Construction Type	Inverter (IGBT based, Digital Control)
Input Voltage	120V/240 V (± 10%) 50/60 Hz
Phase	1 Phase 50/60Hz
I1MAX Current Rating (Inrush Amps)	120V @ 35A 240V @ 31A
I1EFF Current Rating (Rated Amps)	120V @ 24A 240V @ 23A
OCV	68V
TIG Duty Cycle (Rated at 40° C @ Max Output) *	120V: 60% @ 125A 240V: 60% @ 200A
Stick Duty Cycle (Rated at 40° C @ Max Output)*	120V: 35% @ 100A 240V: 35% @ 160A
TIG Output Range V/A (DC / AC) 120/240V	120V: 10.2-15V/ 5-125A 10.8-15V/ 20-125A 240V: 10.2-18V/5-200A 10.8-18V/ 20-200A
Stick Output Range V/A (DC Only) 120/240V	120V: 20.2-24V/5-100A 240V: 20.2-26.4V/5-160A
TIG Start Type	HV, Remote Lift with Switch or Pedal (HV is a digitally controlled electronic HF type start.)
Pre Flow / Post Flow Gas Time	0-10 Seconds/0-25 Seconds
Start Amps (Initial Current); End Amps, DC/AC (Crater Current)	5A/20A ; 5A/20A (Fixed, non adjustable for both)
Upslope/ Downslope (Ramp up/Ramp Down Current) Time	Fixed, non adjustable / 0-25 Seconds
TIG Pulse Frequency (AC/DC Standard Type)	.5-150Hz (Pulses Per Second)
TIG Pulse Time On (Duty Cycle)	10-90%
TIG Pulse Amps (Background Current)	5-95% of Welding Amp Value
AC Wave Form(s)	Adv. Square Wave
AC Frequency	20-250 Hz
AC Balance (Cleaning, % of Electrode Positive)	20-80%
Spot Timer	Not Available On This Model
Stick Arc Force Control	0-100%
Stick Hot Start Intensity	Auto Regulated
Stick Hot Start Time	Auto Regulated
Recommended for Stick E6010 (Cellulose Type Electrodes)	No
TIG Gun Type/Length/ Connector Type	Rigid Neck, 26 Series Air-Cooled, 12.5 ft.(4m) DINSE 35/50 (1/2 nom. dia.)
250A Work Clamp with Cable Length	6.5 ft (2m) DINSE 35/50 (1/2 nom. dia.)
250A Stick Electrode Holder Length	9.5 ft (3m) DINSE 35/50 (1/2" nom. dia.)
Power Cable Length	6.5 ft (2m)
Power Plug Type for 240V (Adapter Included for 120V)	NEMA 6-50P (North American Standard)
Dimensions (Approximate with handles installed)	18" H X 10" W X 25" L
Weight (Bare Unit)	56 bs.
Fan Cooling Type	Fan starts when arc is struck and continues to run briefly on a timer after arc stops.
Ingress Protection Rating	IP21S

Setup Guide

Getting Started

UNPACK YOUR UNIT.

Upon arrival, you will need to completely unpack your unit, and check things over. This is a time sensitive matter. Do not delay or hold the welder unopened in the box. First, make sure the unit is opened from the top. Be careful with using knives and sharp objects so you won't cut cords and cables inside the boxes. Lay all items out and inspect them.

You should have the following in your box:

1. Welder
2. Foot Pedal (Deluxe Style Standard, NOVA Style Optional)
3. Floating Ball Type Brass Argon Regulator with Tubing
4. 26 Series Air-Cooled Torch (Rigid/Straight Neck) 12.5 ft.
5. Torch Switch (Usually attached to torch) for 2T/4T operation
6. 250A Stick Electrode Holder (approx. 9.5 ft with cable)
7. 250A Work Clamp (approx. 9.5 ft with cable)
8. TIG Consumable Starter Kit (No Tungsten)
9. 120V Pigtail Adapter.



Inspect the welder for damage. Check for the presence and general condition of the accessories. Some slight rubbing or chaffing of some of the accessories may be present, but this is considered normal. If any item is damaged or missing, please inform Everlast within 72 hours of product receipt. See pages 4 and 5 for more details. Assemble the front, middle and rear handles with the supplied screws. Do not overtighten the screws.

NOTICE:

The foot pedal may arrive with the top separated from the bottom. This is not damage. The top can easily be installed on the bottom, by aligning the pivot pins with the corresponding holes for the pins located in the top. The pins are spring loaded and can be squeezed so that the top slides down onto the pins. The pins will pop out into the holes and allow the top to pivot once the pins and holes are properly aligned. You may need to make sure the pressure return spring is flipped so that it pushes back against the pedal as it is assembled. Similarly, the foot pedal may be disassembled simply by pressing in on the ends of the pins on both sides to remove the top.

POWER UP AND TEST YOUR UNIT.

You will need to fully test the unit as soon as possible. Within 72 hours after receipt of the unit, be sure to have every thing you need at hand to test the unit. Make sure the correct input power, wiring, and plug configuration is being used. Then, power up your machine without any accessories installed. Allow the unit to idle for 15 minutes. Check and observe operation of knobs, controls and buttons, cycling through each as required. Make sure the fan is running at full speed when arc is struck. After the test is completed, turn the

unit off, connect the accessories, shielding gas (customer supplied) and conduct live testing of all the functions and features of the machine. For testing and welding make sure work clamp is connected directly to the part being welded (work). Check for arc starting and stability. If problems are observed, contact Everlast. See page 5 for more information. **NOTICE:** *Cosmetic damage claims after 30 days will not be accepted, unless Everlast is contacted and informed of such delay and reason for such a required delay (ie. Overseas in deployment)*

CHECK FOR GAS LEAKS.

Be sure to check for gas leaks before attempting to weld. You can test this by first installing both back caps into the torch head (from both sides). Next install the regulator and tighten to both cylinder and unit (see section on regulator installation). After the regulator is secured, set post flow time to maximum. Trigger a false start with either the foot pedal or torch switch by tapping and releasing so that post flow can flow. Observe the ball on the regulator. It will briefly float before settling back down. If the ball continues to flow, or if you hear or suspect leaks, use warm, soapy water (or a dedicated leak testing solution available from welding suppliers) and spray on all connections, including the torch connections at the head and handle. If any leaks are present, bubbles will form around the area of the leak. Tighten any clamps or fittings found to be leaking. If the problem cannot be remedied, contact Everlast.

DISTANCE YOUR WELDER FROM YOUR WORK.

As a best practice technique, be sure to locate your welder away from the immediate area you are welding. The fan found in your unit is powerful enough to create strong air turbulence in the weld area. This will disrupt the smooth, even flow of shielding gas around your weld creating unstable arcs, porous welds, and dull finish on the weld. If possible the welder should be located at least 6 feet away from the weld area and should be on a different level to prevent weld porosity and defects being created by the welder's fan system. *Keep in mind that the fan draws air in from the rear and exhausts out the front and the sides of the unit. This information also pertains to the water-cooler, if used.*

GIVE YOUR WELDER SPACE TO COOL.

The welder needs room to cool itself. Place the unit in a place that will allow 18" from all sides to allow for proper cooling. The welder pulls air in from the rear, and pushes it through the unit's heat sinks to cool the electronics. The air is then exhausted through the front panel and side louvers of the unit. If any of sides is blocked or restricted, the duty cycle will be reduced, and overheating will occur, leading to possible damage if the restriction is severe enough. Never attempt to restrict air flow by attaching filters to the vents or modify your fan on-arc control settings.

Setup Guide

Getting Started

CONNECT YOUR UNIT TO THE OUTLET.

NOTICE:

There are special rules centered around wiring an outlet for service with a welding machine. The National Electric Code under Article 630 has developed specific regulations for wiring electrical service for welding equipment. These are different than for other types of service such as a stove or dryer in a household or even in a commercial application. You need to consult and/or employ a locally licensed electrician before installing this unit to make sure all national and local codes are followed. If you are not qualified to make these connections, don't. Everlast is in no way liable for any damages caused by improper connection of your welder. Your welder should be on a dedicated branch circuit not far from an electrical disconnect box. Importantly, it should not share circuits with other shop or household items. Do not attempt to "adapt" existing circuits because conductor (wire) colors are different for welders with 3 wire operation than for a dryer or range with 4 wire operation. (Unless adapting with an approved adapter when being powered with a "clean power" generator.) No neutral is used in a welder circuit. The white wire is a conductor in a single phase welder service. The red wire is not used. *The input power cable conforms to North American standards for size, length, with consideration given to inrush amperage, rated amperage and duty cycle. Do not modify, or attempt to rewire your unit.*

Standard Plug Configuration 1 Phase 240V

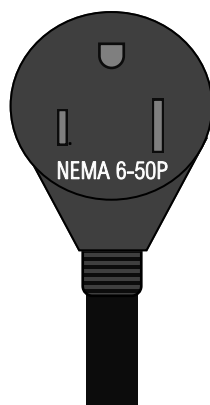

Your unit has been shipped with a NEMA 6-50P welder plug. This is the standard for 240V 1 Phase welders in North America. For single phase 240V connection, select a NEMA 6-50 Receptacle for operation with this unit. (Other regions/countries vary). A neutral is not used. For a dedicated circuit, the wire wires supplying power (the conductors and ground) are black, white and green. A red wire, which is traditionally the "hot" leg of power is not present in the three wire 240V wire circuit of a welder. For welders, from the panel box,

the Black wire serves as L1(Hot), White serves as L2 (Hot) and Green serves as G (Ground). Red will not be used to supply power (on a dedicated circuit). There is no need for a neutral, so white is used as the other "hot" conductor in this instance. It is recommended to either install the receptacle as close to the main panel as possible or install a subpanel cutoff as close as possible to the outlet and welder. Follow local code to determine best arrangement.

This welding unit is also designed to operate on 120V power. While operating on 120V, the output will be reduced. To adapt the unit for 120V operation, the unit has been supplied with a 240V to 120V pigtail adapter. When operation on 120V is required, simply plug this NEMA 6-50R to 5-15P adapter to any standard type wall outlet with either a slow blow fuse, or delayed trip breaker protecting the circuit. The inrush current of this unit can exceed the limits of a typical 15A 120V circuit when used at or near maximum output of this welder while operating on 120V. For best results, use this unit with a slow blow fuse, or a delayed trip breaker on a dedicated 120V 20 or 30 Amp circuit to avoid nuisance fuse blowing or breaker tripping. There is no need to alter or change any wiring or switching required to be able to operate on 120V. The unit automatically senses the input power and adjusts the maximum output of the welder.

240V to 120V Pigtail Adapter (Supplied)

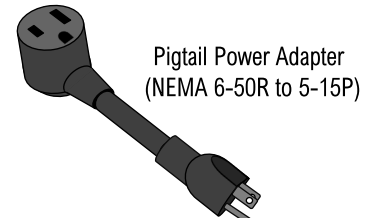

Selecting A Breaker and Wire Size

Select a breaker based off of the I₁MAX rating of this unit. This is the maximum inrush current of the unit. The inrush is not a sustained current. The I₁EFF rating of the unit is the maximum "rated" current of the machine. When combined with the length of the run from the main panel, this determines the conductor size needed to supply the welder, Refer your electrician to Article 630 and the specification page of this manual (or the specification grid printed on your unit) when selecting the correct breaker and wire size. A delayed trip breaker, or slow blow fuse should be used with this unit.

Using with 208V 1 Phase

This unit may be operated with 208V service (1 phase). However voltage should be checked under load before allowing permanent installation. Voltage should not fall below 205V or damage may occur to the unit. Most modern 208V service runs several volts above 208V and is not usually a concern. Older installations where service wiring may be degraded or not up to code may produce sub standard voltage not suitable for use with this unit. Additionally, some accuracy/calibration issues may be observed while on 208V.

Setup Guide

Getting Started

CONNECT YOUR UNIT TO THE SHIELDING GAS.

What Shielding Gas Should Be Used?

Selecting shielding gas for MIG is straightforward. **For all metals, whether using in AC or DC, use 100% Argon.** Never use a gas mix mixed with CO₂. CO₂ will rapidly consume the tungsten and introduce porosity into the weld even at low concentrations.

With that said, if you are welding at or near the maximum capability of the unit, you may also wish to use an Argon/Helium mix. This will increase the overall heat going into the weld. No more than 25% Helium mix should be used with this unit, or Arc starting efficiency will be reduced (hard to start arc). Arc stability will also be affected at higher percentages. Helium is expensive and the cost versus benefit of adding it must be weighed carefully as a cylinder or two of high percentage Helium may approach the cost difference of upgrading to a larger unit! If a high Helium content is used, expect some trade-offs.

There are a few new gas mixes (blends) on the market with promise, but as of publication they have not been thoroughly evaluated for use with this welder. Exercise caution when using a new mixture (often marketed with Nitrogen or Hydrogen) as the application is very specific. Pure 100% Argon is the most economical and best for nearly every application, and having multiple gases should not be a concern for even the most advanced user.

BE AWARE: It is increasingly common for users to get cylinders of "bad gas," creating mysterious and difficult to identify issues. An Argon cylinder is the same type of cylinder as an Argon/CO₂ cylinder used for MIG and sometimes times can get mixed in and relabeled as pure argon. Another increasingly common issue is that a gas mix cylinder gets refilled with Argon with residual Ar/CO₂ mix without using proper purging techniques. Usually this occurs in "batches" and complete lots of cylinders can be affected. Sometimes swapping with another cylinder from the same supplier will not correct the problem. Also it has been found that a customer to specify "Argon" and receive a cylinder marked as Argon/CO₂ mix. Always check your cylinder label below the cap area for proper labeling before accepting the cylinder.

Always wear safety glasses when changing a cylinder. Before installing any cylinder, stand to the side of the valve, away from the discharge, and quickly open the cylinder to give it a quick blast. This will dislodge any dirt or particles stuck in the valve or the connection seat. This will help reduce the chance of dirt particles making its way into the solenoid valve, causing sticking issues later on.

Connecting your cylinder will require a cylinder wrench (1 1/16") to connect the regulator to the cylinder (North American Cylinders with

a 580 CGA valve). If you do not have a cylinder wrench, an adjustable type wrench will work, but make sure it is properly adjusted to prevent rounding of the fitting shoulders. Do not use pliers, or a serrated jaw wrench such as a pipe wrench or basin wrench to tighten the fitting. The design of the fitting means that no thread sealing tape or compound needs to be used.

Connect the regulator tubing to the regulator. The regulator may have either a hose barb connection, or a threaded connection. If the regulator supplied has a hose barb, make sure the hose barb fitting is tight on the regulator. Tighten with a 3/4" (19mm) wrench. If it is a threaded connection, use two 3/4" (19mm) wrenches to hold both the regulator and the tubing connection at the same time. Hold counter pressure on the regulator connector while tightening the hose fitting to prevent damage to the regulator and to ensure maximum sealing. After connecting the tubing to the regulator, connect the other end of the tubing to the 5/8" CGA fitting on the unit. Hold the fitting on the unit with one 3/4" (19mm) wrench firmly while tightening the hose fitting with another 3/4" (19mm) wrench. **Important!** Do not use thread tape or pipe sealant on any cylinder, regulator or unit connection. The residue and debris may get into the gas solenoid and cause operational issues.

CAUTION! Do not tighten the rear unit connection without holding the female fitting on the unit with a wrench, or damage may occur to the bezel as the fitting may turn in the plastic housing while the hose fitting is being turned.

Connect Regulator To Cylinder And Unit.

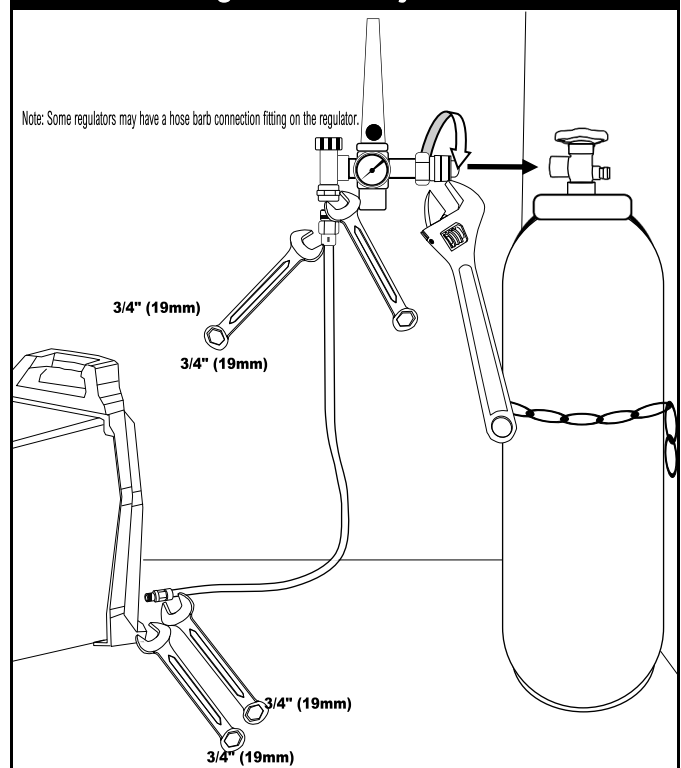

Setup Guide

Getting Started

SELECT THE PROPER TUNGSTEN TYPE.

What Type of Tungsten Do I Use?

Selecting the correct tungsten for your welder is important. Modern Inverters no longer use Pure (Green band) Tungsten for welding AC. In fact pure Tungsten used with an inverter can create problems with arc stability, arc starting and excessive balling. While Thoriated 2% Tungsten can be used in an inverter for DC, and even for AC welding, it is falling out of favor in the industry due to the slight radioactive nature of it, and it does present some issues while welding in AC than other choices. But it is still an industry standard.

For welding in AC and DC consider the following types.

- Lanthanated 2% (Blue Band). Overall this is one of the best choices for TIG welding and can be used for AC and DC welding. It has great arc starting characteristics, and its point holding capability is excellent.
- Ceriated 2% (Gray Band or Orange Band, depending upon brand and country of origin). This is a good choice for welding with both AC and DC, but doesn't hold up as well and starts to erode faster than Lanthanated at higher amperages. But arc starting is excellent.
- Lanthanated 1.5% (Gold Band). Holds up nearly as well as Lanthanated 2% and can be used for AC or DC welding. In some tests it has rivaled Lanthanated 2% performance.
- Tri-Mix/Rare Earth (Purple Band or Turquoise Band). Still relatively new. Some swear by it, and is being marketed as a replacement for Thoriated 2%. Overall, it does perform fairly well and even excels in many circumstances. But some problems have been seen with quality control. The primary metal oxide used is lanthanum 1.5%. Usually it also includes a small percent of Zirconium and Cerium to complete the mix. Some use Yttrium. But the balance of the composition blend are usually stated to be around .06 to .08%, but can be allowed to vary up or down from .04% to .01%, making the blend prone to inconsistency in quality control.
- Thoriated 2% (Red Band) Still considered the best for DC, works ok for AC, but has been banned in many markets outside the US due to a small radiation risk posed as an alpha emitter.

Do not use the following types of Tungsten.

- Pure Tungsten (Green Band). This will create arc instability. The tungsten will not stand up well to the more intense arc created by an inverter welder.
- Zirconiated Tungsten (White Band). This was created as an alternative for Pure Tungsten for Transformer welders. Similar welding issues are presented as with Pure Tungsten.

Purchasing Tungsten can be difficult. Local suppliers tend to put a premium price on Tungsten, and may be three times an online price direct from a distributor. In many areas, the choice of tungsten may be limited. However, many local welding suppliers are stepping up and offering competitive prices and range of selection, so don't rule them out until you have checked. Also, there are some companies that may send you free samples to test, so be sure to investigate their product, and give them a chance as well.

GRIND THE TUNGSTEN CORRECTLY.

An improperly ground tungsten is a cause of many issues with arc stability, arc directability, and penetration. A bench grinder and a fine stone dedicated only for tungsten sharpening is all you need to put a point on the Tungsten. This is the age old standard. This does take practice to master. However, there are hand held special grinders that feature diamond stones with guided slots, designed to hold the tungsten at the proper angles. A chemical sharpener is available and is relatively inexpensive, and does an excellent job in seconds. An added bonus of it is that it can be done without getting up from the bench top without removing the tungsten from the cup. The tungsten should be hot before attempting as this activates the chemical.

! WARNING!

Wear safety glasses and leather gloves while grinding tungsten or serious injury may occur. On occasion tungsten may split or shatter. Do not breathe or inhale tungsten dust. Do not use angle grinders!

How Do I Grind My Tungsten?

- Grip the Tungsten firmly. Grind with the tungsten secured.
- Grind the Tungsten perpendicular to the wheel face. Allow tungsten to grind slowly without much pressure.
- Rotate the Tungsten quickly as it is being ground to keep the point even and symmetrical.
- Do not grind the Tungsten parallel to wheel face or an unstable arc will result.

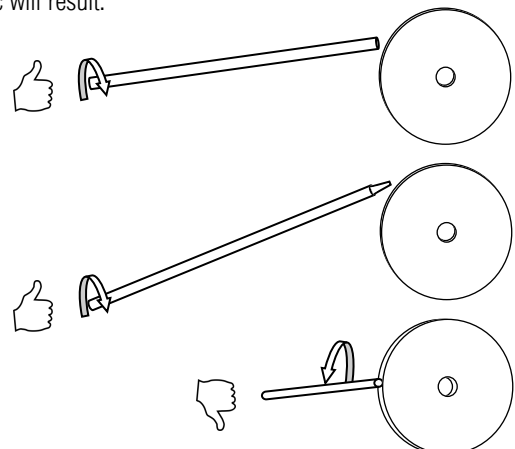

Setup Guide

Getting Started

Choosing the proper grind angle is important to achieving the weld penetration, bead appearance, and arc cone width that you desire. While there is no true “one size fits all” angle, there are some general rules of thumb to observe:

- Always grind in-line with the length of the tungsten. Never make radial grind (in the direction of the circumference) marks on the tungsten which will cause arc instability. Never grind with the tungsten held parallel to the stone face.
- For most applications, grind a point that is 2 –2.5 times in length than the tungsten is wide. This will create an angle of about 30° to 35°.
- For AC, a more blunt angle may be used (around a 60 degree) for best penetration. However, the 2 to 3 times in length rule will still work for many circumstances.
- For higher amperages, you will want to put a slightly truncated tip on the tungsten.
- Grip the tungsten firmly and slowly rotate it while grinding.

What Type of Grind Works Best?

- Never use a radial grind pattern. This can be caused by grinding at the wrong angle, or spinning the tungsten too fast while grinding at the proper angle. The arc will be unstable.

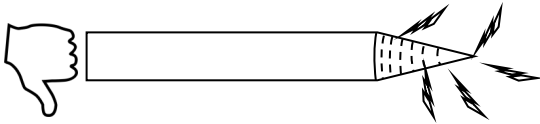

- Grind the angle so that the length of the grind measures 2 to 2.5 times the wide of the tungsten (For general purpose use this should form about a 30° to 35° angle.) A slightly blunted end (truncated) may be used if the amperage is over 50A to prevent the tungsten from breaking off into the metal while welding.

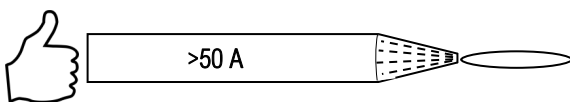
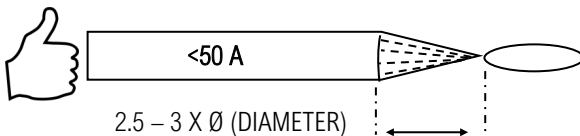

- AC welding may require a blunter point for some applications where greater penetration is desired. It may seem counter-intuitive, but this will create a narrower arc cone and provide more penetration.

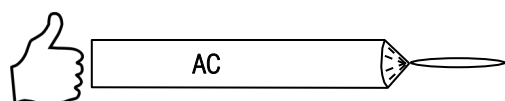

As you use the tungsten (depending upon the type you have selected) you will notice that the tungsten will gently form more of a pointed dome as it is used, especially on AC. This is normal and the arc will remain stable. Depending upon what arc properties you are looking for, you may periodically want to regrind your tungsten to maintain optimal arc characteristics.

IMPORTANT! Don't Ball The Tungsten.

If you've ever operated an older transformer welder, or an early inverter, you were probably balling the tungsten when welding on AC. In fact tons of literature exist about proper size ball, how to ball etc. In fact, well meaning instructors and seasoned welders (who have never worked with an inverter) may even insist you weld this way today.

However this is no longer true with an inverter. In fact, if you insist on balling tungsten with an inverter, you are going to create an unstable arc, and in general hate the way it will weld. Be warned. Don't blame the machine. Blame the ball.

Why? The old “Green” tungsten is considered to be pure tungsten. This meant that it did not handle heat as well at higher temperatures as with the more modern tungsten blended with rare earth metal oxides, and would even ball on its own as it was used. But it was also needed to hold a certain type of arc cone. An intentional ball would help the tungsten handle the arc better on a transformer.

Modern inverters treat green tungsten rather roughly, and you'll quickly end up with a huge, molten liquid ball dangling at the end of the tungsten on AC. This is in part due to the short off time between polarity change from + to - and back to + during the AC cycle. In fact this time is so short, that inverters do not need High Frequency Stabilization (HF) while welding AC, and do not have it. (On this model the unit features HV start, a digitally controlled, solid state form of HF.) The extra “time on” of the arc means the tungsten is hotter, and pure tungsten (green) isn't able to handle the heat and will over-ball. That is why rare earth metal-oxide blends are recommended. They do handle the heat better and actually conduct electricity better. So they do not need a ball. If given enough heat at the high end of their operating range (for the diameter of the tungsten) they will form a slight, but neatly elongated dome. But this dome still isn't a ball.

If you think about it, the big ball at the end is really a large “target” for the arc to jump to as it reverses polarity. When the electrons begin to flow from the plate to the tungsten, that is a bigger target for the electrons to hit, so the arc could end up anywhere along that balled surface. The bigger the target, the more room for the arc to oscillate around the ball, creating a randomly wandering arc. This is why pointed tungsten is recommended with inverters.

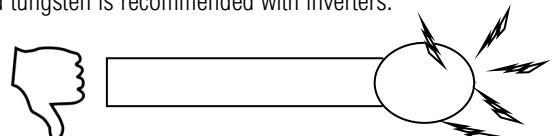

Setup Guide

Getting Started

SELECT THE PROPER TUNGSTEN SIZE.

What Size of Tungsten Do I Use?

Everlast advertises low arc start capability on their units. Surge Amperage to establish the arc are quite low. When starting an arc, some brands have a high surge in amperage to start the arc, lasting just a fraction of a second. This surge isn't usually reflected in the display. This surge ensures good arc starting, but can blow through thin materials before the arc is established and welding begins at a lower amperage. Everlast has kept the surge to a minimum. However, when welding with thicker tungsten like 1/8", arc starts may appear "soft" and not forceful enough to start cleanly. For best results, when low amp starts are needed, use a 1/16" or .040" tungsten. Arc starts will be clean and crisp.

The tip angle and grind preparation will ultimately affect amperage carrying capability of the tungsten. Machine wave form can also affect it. Each type of Tungsten blend will vary in amperage handling capability, but in general, consider the following for selecting your tungsten diameter. The list below is not the absolute maximum range of the tungsten, but recommended range. Absolute range is up to 30% higher. However, it is a good practice when you approach the maximum limit of the tungsten's capability in terms of amperage, that you switch to the next size up for best point retention and arc characteristics. **AC operation can reduce tungsten amperage capability.** The setting of the AC balance and AC frequency has an effect on tungsten point holding capability. Too much cleaning (over 40% EP) will over heat the tungsten and ball it. Lower frequencies tend to place more heat on the tungsten as well. But in general, for AC and DC operation, consider the following:

- .040" (1mm) 3-30A
- 1/16" (1.6mm) 5-70A
- 3/32" (2.4mm) 10-200A.
- 1/8" (3.2mm) 20-250+A

NOTE: Starter kit does not include .040"(1mm) collets.)

The key to obtaining good, picture perfect arc starts is to use properly sized tungsten. A properly sized tungsten, combined with correct sharpening technique will display the best arc characteristics. An undersized tungsten will tend to ball at higher amperages, especially if the tip is too sharp for the application. An oversized tungsten will be more difficult to start at lower amps.

NOTICE:

A larger tungsten such as a 1/8" diameter or larger may not start as cleanly at the minimum capable start amp of this unit. If arc wander or difficulty establishing a stable arc exists and you need to operate and weld at a much higher amperage, increase the Start Amps to 25 Amps. A higher start amperage may be selected if needed for more rapid puddle development, but usually is not used with a foot pedal.

NOTICE:

The minimum start Amp of this welder in AC is 20 Amps. For DC it is 5 Amps. The minimum Tungsten size used will depend upon whether you are welding in AC or DC mode. 20 Amps can cause .040" tungsten and in some cases 1/16" tungsten to melt. To achieve the best start operation on AC, maintain low AC balance settings and at least 50 hertz with smaller diameter tungsten. Use at least .5 seconds preflow to offer the tungsten maximum shielding gas protection to reduce consumption at the start. Use Blue Stripped 2% Lanthanated Tungsten for the greatest flexibility of Tungsten diameters and to offer the best start stability at 20 Amps.

Setup Guide

Getting Started

SELECT THE PROPER TIG POLARITY AND CONNECTIONS.

Selecting polarity for TIG is quite simple. The torch will always be connected to the negative (-) output terminal located on the left. This is whether it is welding in DC or in AC. Once the TIG torch is in the negative terminal, never change it. Selecting the wrong polarity with TIG will quickly consume your tungsten. It will ball up and draw back to the collet body after only a few seconds when the arc is initiated, especially when higher amperages are used. Many times the arc will even be hard to start, since the HV starting energy would be flowing the wrong way. Of course that means the work clamp is in the positive (+) terminal on the right.

The TIG torch switch or the Foot Pedal is connected to the 7 pin control connector. This allows you to select 2T or 4T control with the torch switch OR foot pedal control. **Since there is only one connector, you will need to determine which operation you will use and select either the TIG torch switch or the Foot Pedal and plug it in.**

Where Do I Connect The TIG Torch?

Air-Cooled TIG Torch

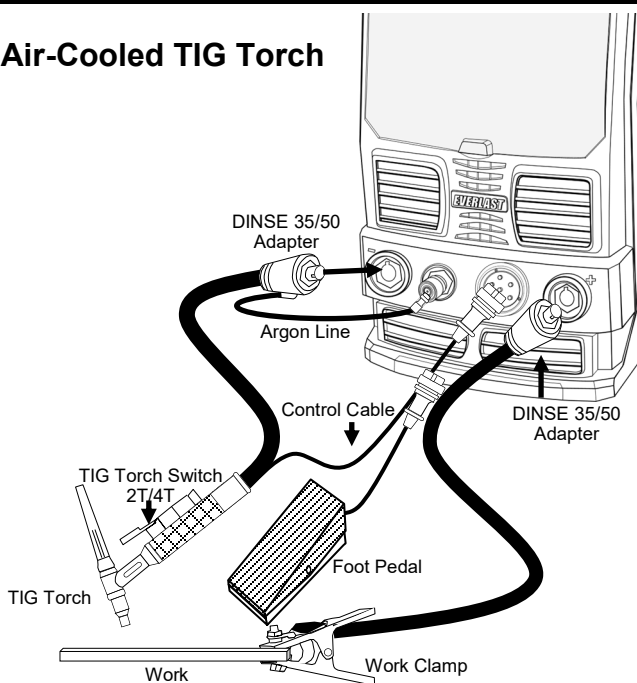

NOTICE: Choose between the torch switch operation (2T/4T) or the foot pedal operation. Both cannot be used at the same time.

KNOW THE DIFFERENCE BETWEEN AN AIR COOLED AND WATER COOLED TORCH.

An air-cooled and water-cooled torch connects differently. An air cooled torch for this unit will have one line exiting from the DINSE Connector. This is the gas/argon line. The water cooled torch will have 3 lines. Two descending from the torch, and one exiting from the DINSE type connector. Traditionally, the black line descending down from the torch will be the argon line. (Some brands vary

in color coding, so match the color codes of the torch to the cooler couplings for best results). The line exiting from the DINSE connector is no longer a gas line but a water line. Traditionally this line is the return line to the water cooler. The remaining line will be the input line from the water cooler. If in doubt, blow through the torch lightly with compressed air to determine torch flow through the hoses. Some NOVA torches use the line from the DINSE connector as the input. Follow the color coding used by NOVA.

Where Do I Connect The Torch?

Water-Cooled TIG Torch

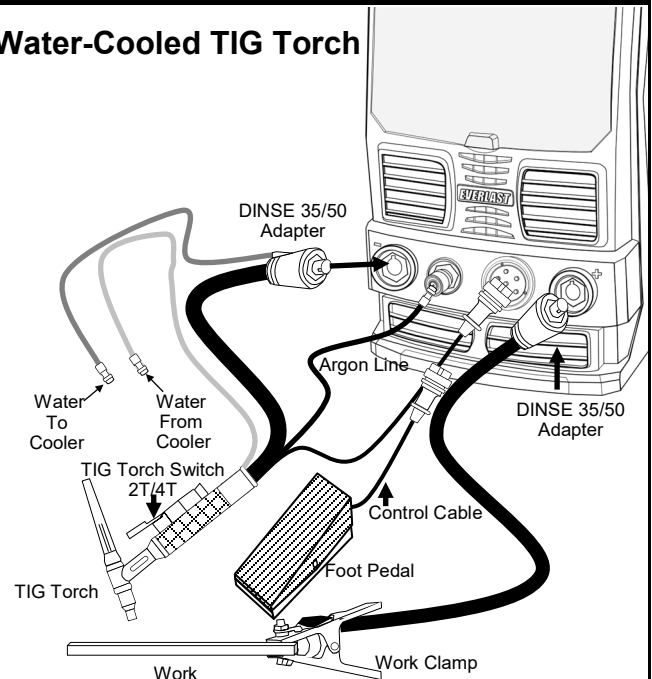

NOTICE: Choose between the torch switch operation (2T/4T) or the foot pedal operation. Both cannot be used at the same time.

WARNING!

A water-cooled torch must be operated with a water-cooler or permanent damage will occur to the torch. Any operation without water can damage the torch. There is no safe amp limit for operation without water. If you have a water cooled torch and no cooler, you must order a cooler before you use the torch, or purchase a separate air-cooled torch. If an air cooled torch is purchased, observe the amp limits of the torch. The largest air-cooled torch (26 series) maximum amperage at 60% duty cycle is 200A DC, and 175 AC. If Amperages are to be welded over that, you must purchase a water cooler. Torches operated without water, or sustained amperage over their rating and duty cycle, are not eligible for warranty replacement. Always match the torch to the job. Usually most users find that one torch is not enough and several torches may need to be purchased to suit different welding applications. Each torch size/class has different amp limitations. **Know these limitations before using!**

Setup Guide

Getting Started

GET A COOLER IF YOU HAVE A WATER-COOLED TORCH OR WELD OVER THE AMP LIMIT OF YOUR AIR-COOLED TORCH.

The new design of the PowerTIG units features an improved, seamless pairing of the welder and the water-cooler. The new PowerCool series of water coolers are designed to stack under the units, with a matched sheet metal and front and rear fairings. These will interlock and provide a slip free connection.

For cooler connection, stacking of the welder over the cooler and general information on using a water cooler with your unit, see the water cooler manual. This unit is designed to stack with the new PowerCool cooler. If you have any questions about purchasing the correct cooler and assembly for your welder, contact Everlast.

SELECT THE PROPER STICK POLARITY.

The electrode holder, or stick torch (sometimes called a stinger) will almost always be connected to the right terminal of the machine (positive+). The work clamp will be connected to the negative. This is known as DCEP (DC, Electrode Positive), Although it is an older term, this is sometimes known as “reverse polarity” Most all welding rods weld primarily in DCEP. DCEN (DC, Electrode Negative), although an older term is sometimes called “Straight Polarity”. There are a few rods like E6011 which can operate either way, but the preferred polarity is DCEP. Reasons for welding with DCEN are usually to provide a softer arc, or reduce burn through.

IMPORTANT!

This unit is designed to operate with most welding rods. However, this unit is not designed for use with E6010. This unit should operate with E6011, however, which is considered to be a similar rod in characteristics. When welding with E6011, some brands may weld differently than others. Always select a good quality brand for best arc stability. If instability is observed with E6011, switch brands. This unit operates best with a short arc, so either drag the rod, or hold a very short arc length so that arc outages with E6011 are not experienced. A dragging motion, or a slight weave is recommended, but increasing the arc length may result in arc outages. Rods like E7018, and E7014 are highly recommended for use.

Where Do I Connect The Stick Torch?

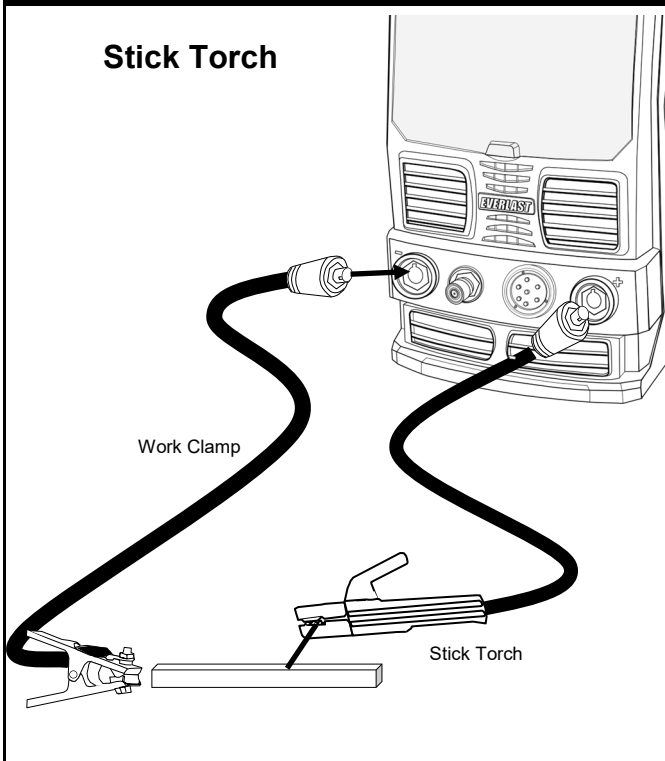

Setup Guide

Getting Started

If you are needing basic help getting started, here are some general settings and selections to get you started. This guide is intended to be only a starting point, not a completely exhaustive source. Keep in mind that no guide is a substitute for practice and experience. You may find that your final settings may be different from the ones listed. **The following guide does not represent the maximum capability, or even the recommended capability of the unit.** However, it demonstrates what is considered to be a practical capability limit of multiple variables when factored together. It is possible to weld thicker materials with the same amp range. However, as a best practice, the industry does not recommend heavy passes, rather thinner “stacked” passes on thicker plate. Multi-pass welds are typically stronger, have less defects and require less amperage. On heavy gauge plate, such as 3/8” up to 3 to 5 passes may be required. Additionally beveling of the joint is required for complete joint penetration, even at higher amperages. The thickness rating takes into account the “heat sink” capability of the metal, and the power of the amperage to overcome the conductivity of heat of the metal used using multiple passes. The position of the weld also influences the amperage, cup size, gas flow rate and tungsten size used. For the following recommendations, these are all in “flat” position. Modify your settings accordingly. Vertical will require less amperage the more you weld “up hill”.

Amp Range	Metal Thickness Aluminum (AC)	Metal Thickness Steel/Stainless (DC)	Electrode Dia.	Cup Number	Flow Rate (CFH) Standard Lens	Flow Rate (CFH) Gas Lens
3-30A	.005” to .030”	.003” to .035”	.040 (1.0 mm)	4 or 5	5 to 7	4 to 5
5-70A	.005” to .0612”	.005” to .093”	1/16 (1.6mm)	4, 5, 6	6 to 12	6
10-200A	.010” to .250”	.08” to .375”	3/32” (2.4mm)	5,6, 7 or 8	10 to 18	8 to 12
20-250A	.020” to .375”	.015” to .500”	1/8” (3.2mm)	6,7,8 or 10	15 to 25	10 to 18
50A-350A	.050 to .625”	.050” to .750”	5/32 (4mm)	8-10	20-30	15-25

Cup Size	Inside Diameter
4	1/4”
5	5/16”
6	3/8”
7	7/16”
8	1/2”
10	5/8”
11	11/16”
12	3/4”

NOTICE:

The minimum start Amp of this welder in AC is 20 Amps. For DC it is 5 Amps. The minimum tungsten size used will depend upon whether you are welding in AC or DC mode. 20 Amps can cause .040” tungsten and in some cases 1/16” tungsten to melt. To achieve the best start operation on AC, maintain low AC balance settings and at least 50 hertz with smaller diameter tungsten. Use at least .5 seconds Pre flow to provide the tungsten with maximum shielding gas protection so that tungsten consumption can be reduced during the arc start. Use Blue (painted band color) 2% Lanthanated tungsten for the greatest flexibility of tungsten diameters and to offer the best start stability at 20 Amps.

Component Identification and Explanation

Front Panel View

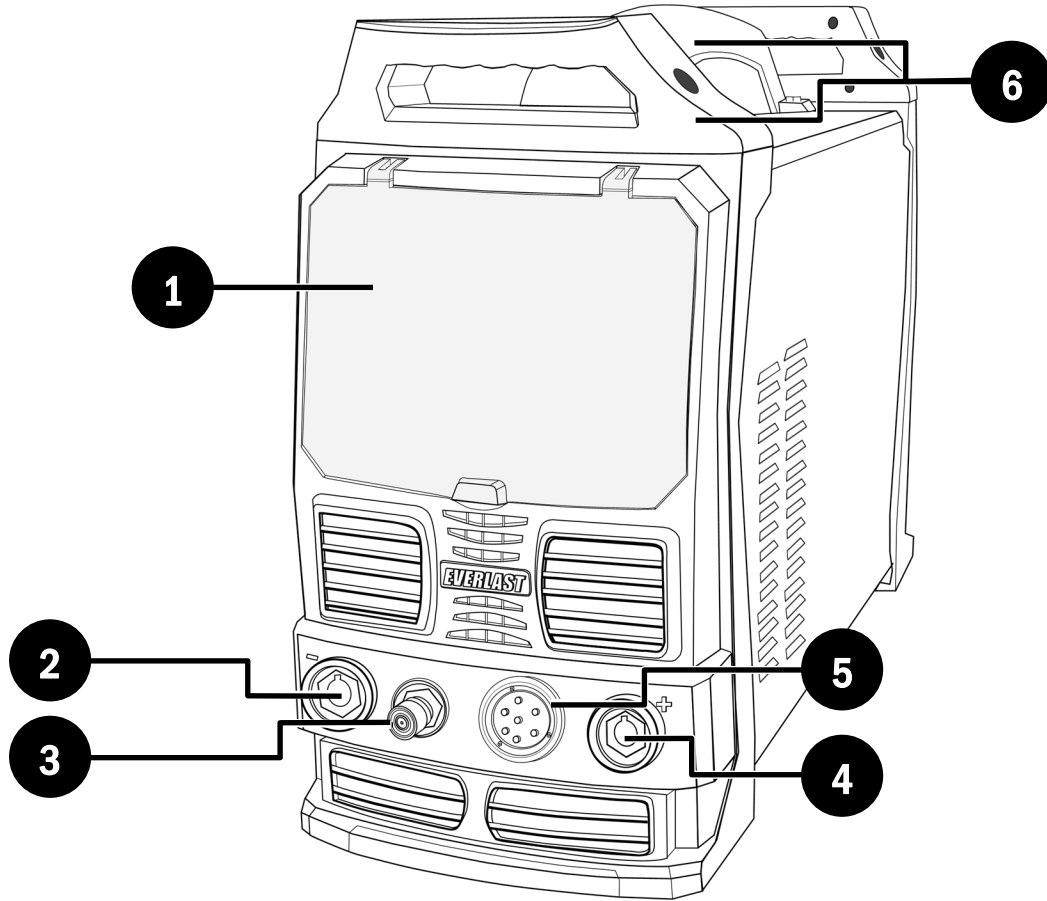

Number	Component Identification	Component Note
1	Protective Cover	Keep down and in place during welding activities and in storage.
2	Negative Terminal (-) (DINSE 35/50 Type, 1/2" nominal dia.)	Connect the TIG torch to this terminal for all TIG welding applications including AC. Connect the work clamp to this terminal for most Stick welding applications
3	Shielding Gas Connector (Quick Connect, 9mm tube Type 21)	Single Shut-off Type for Inert Gas. Ref. EV-9MM-B-QUICKCONNECT-STDSET or 21KATS09MPX
4	Positive Terminal (+) (DINSE 35/50 Type, 1/2" nominal dia.)	Connect the work clamp to this terminal for all TIG welding applications including AC. Connect the Stick Electrode Holder (Stinger) to this terminal for most Stick welding applications.
5	7 Pin Control Connector (5/8" Type GX16-7)	Ref. EV-PANA7-625-PLUG
6	Handles	Assy. Required, removeable for Low Clearance applications

Component Identification and Explanation

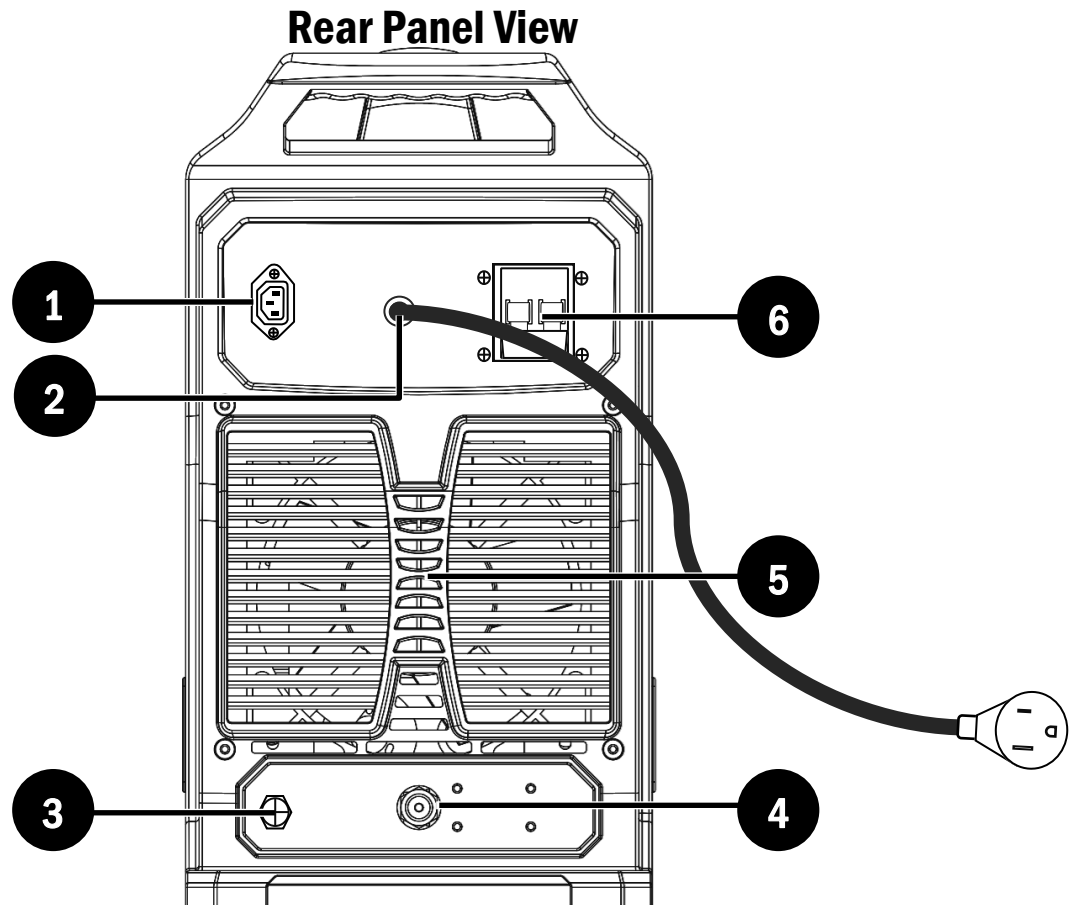

Number	Component Identification	Component Note
1	Water Cooler Plug (240V 1ph, 4A max)	This plug is to be used with Everlast water coolers only. Do not use with any other application.
2	Input Cable*	Plug is not included due to dual phase capability and the different wiring arrangements required. <i>North America only:</i> The unit may be operated on either 208-240V 1 phase or on 120V 1 phase. North American standards require only 3 wires for 1 phase operation of welders. A neutral is not used or required. For wiring a 1 phase connection to the unit: Use Black for L1, White for L2, and Green for ground (not neutral) use. Red is not typically used in wiring a dedicated welder circuit. If the cover is removed to determine wire color, you'll notice a red wire will not be present. This is according to standard. However, this presents a problem when wiring into old services where red may be present where a 4 wire system or older 3 wire is used with a neutral (white wire) and a ground (green wire). While a welder operates on 240V single phase, a Neutral is not used and the white and black wires are used as conductors for a dedicated welder circuit. If a red wire must be used as a conductor, then the black conductor should be matched to the black wire on the welder and the red conductor should be matched to the white wire on the welder. When operating on 120V, the white wire (internally) becomes the neutral, and the green still serves as the ground. <i>The supplied NEMA 6-50P is the proper plug used for wiring single phase 240V welders in North America. It should not be changed or removed unless wiring directly into a cut-off switch.</i>
3	Ground Service Bolt**	For use in a combined effort to mitigate any electrical interference that may be caused by the operation of this unit.
4	Shielding Gas Inflow Connector (5/8" CGA)	<i>North America:</i> 5/8" CGA connector. <i>Other Markets:</i> Hose Barb connection.
5	Fan location	Periodically check for proper fan function and cleanliness. This unit features an "on arc" fan control
6	Breaker/Power Switch.	This switch doubles as the main power switch and disconnect switch. If this switch trips and the welder power turns off, a significant internal event or failure of the switch <i>may</i> have occurred. If this occurs, immediately remove from service and mark/tag according to regulations and contact Everlast Tech Support for further diagnosis and/or repair options.

***NOTICE:**

When the Pig-tail adapter supplied with this unit is used, it correctly connects the unit for 1 phase 120V use. No change of wiring, or shunt/switch settings on the unit is required.

****NOTICE:**

If any electrical disturbance is noticed as a result of the High Frequency operation of this unit during arc starting, the ground service bolt should be connected directly to a 12 gauge wire that is bonded directly to an outside copper ground rod driven into moist soil. Additionally, all metal items including any metal frame or sheeting of the building should be connected and grounded to separate copper ground rods driven into the ground at 10 foot intervals around the perimeter of the building. This includes items such as tables, carts, rack material, metal surrounds, etc. that may act as "antenna" to radiate/absorb HF energy. Additionally, all cords and welding leads should be twisted together and run directly to the work without coils or excess cabling.

Component Identification and Explanation

Control Panel Layout

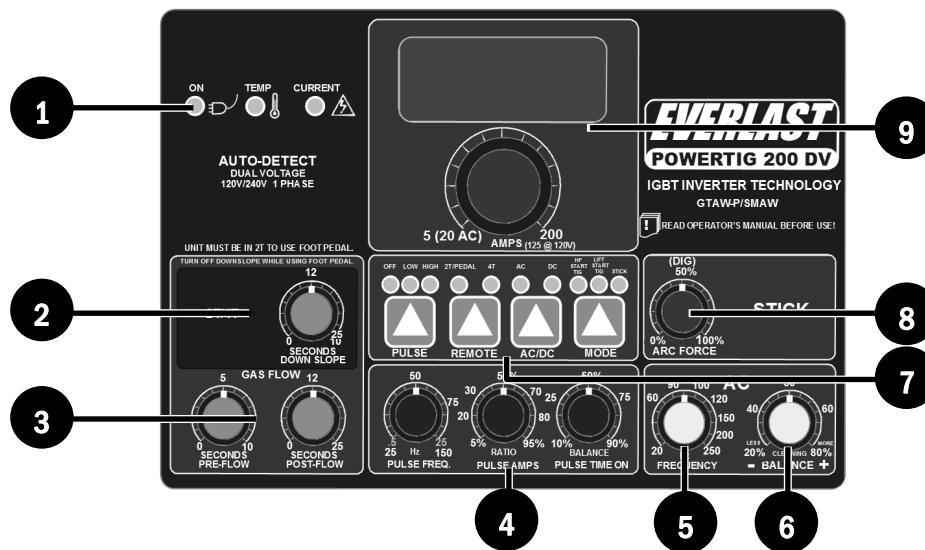

Number	Component Identification	Value	Function/Component Note
1	On/Temperature/ Over Current/Voltage	NA	“On” will be lit while unit is switched on to confirm power. If the temperature light is lit, an overheat has occurred. See cool down and duty cycle instructions on page 11. An overcurrent light signals a significant operational problem, including, operating on too low/high of voltage, too long of extension cord, operating on a generator not rated as “clean power”, and/or some internal event that caused an excessive current draw. Check for issues then attempt one reset, if this does not clear or reoccurs shortly after, contact Everlast Tech Support.
2	Down Slope	0-25 Seconds	The Down Slope controls the ramp down cycle time during 2T/4T use with the torch switch. Do not use with the foot pedal. (Set to “0”)
3	Pre Flow/Post Flow	0-10/0-25 Seconds	Used to provide pre-weld gas flow and post-weld gas flow to protect the tungsten and the metal being welded from oxidation and porosity. Used with 2T/4T and Pedal.
4	Pulse Includes Pulse Frequency, Pulse Time On, Pulse Amps	0-500Hz 10-90% P.T.O. 5-95% Pulse Amps	Includes Pulse Frequency (represented as Hertz, or pulses per second) Pulse Amperage Percent (the drop of the pulse amps during the pulse cycle) and Pulse Time On Percent (how long the peak part of the pulse stays on in relation the lower amp stage of the pulse cycle).
5	AC Frequency	20-250Hz	Represented in Hertz, this is the number of times per second one complete cycle from Electrode negative to electrode positive and back to electrode negative occurs. Controls arc cone focus.
6	AC Balance	20-80% of positive	Represented as a percent of Electrode Positive (EP), this controls the cleaning/penetration of the arc when welding in AC mode. Usually set between 20% and 40%. Higher settings result in tungsten balling.
7	Function/Process Selectors	NA	Used to select turn on or select the desired features of the unit. When the LED is lit, this means that the process/function over the LED has been chosen.
8	Stick Arc Force Control	0-100%	Allows you to set the arc reaction characteristics, from hard, driving, to soft, smooth arc by changing the amp increase when arc voltage falls in short arc conditions.
9	Control Knob/Display	TIG 5(20)-200A Stick 5 to 160A	Control knobs adjusts maximum amperage. The display displays only the welding amperage. Display will read according to process and mode selected. For TIG, Amps will read from 5 to 125A in DC mode while operating on 120V input. While operating on 120V input in AC mode, the range will read from 20 to 125A. While operating in DC mode while operating on 240V input, Amps will read from 5 to 200A. While operating in AC mode, while operating on 240V input, Amps will read from 20-200A. For DC Stick, Amps will read from 5 to 160A while operating on 240V or from 5 to 100A while operating on 120V.

Component Identification and Explanation

Explanation of Functions and Welding Terms

AC. Alternating Current. Used in TIG mode on this welder to weld Aluminum and Magnesium. AC does not function in Stick mode.

AC Balance. The AC wave form is formed by alternating the arc polarity rapidly between electrode negative and electrode positive. The polarity change is simply the change in the flow direction of the electrons. The electrode negative half of the wave form provides most of the penetration and heat that goes into the weld as the electrons flow from negative to positive, or in this case from the torch to the weld puddle. The Electrode positive half only puts a small amount of heat into the weld as the flow of electrons travels from the puddle to the Tungsten. But it does provide "cleaning" by removing the oxide layer from Aluminum and magnesium as it reverses the flow of electrons, literally breaking and ripping up the oxidation, leaving clean areas under the immediate area of the weld puddle and along the sides. If the wave form "halves" are equal in length this means an equal time is spent between the positive and negative stages of the AC cycle. Even though cleaning is needed, there are problems with AC positive polarity. When the AC cycle enters the positive polarity stage, excess heat builds up on the Tungsten and it begins to ball due to electrons flowing from the weld to the tungsten. Little heat is put back into the weld. Another issue is the excess cleaning can occur and the weld will have wide areas of etching (cleaning) on the sides of the weld, which are generally undesirable. Modern transformer welders were able to slightly skew the "balance" of the wave form, making one "half" of the wave form longer than the other "half". In other words instead of having a 50/50 balance, they were able to create a 40/60 balance, but this adjustment was limited. With modern inverters, the wave forms are much more adjustable and the balance has even greater adjustment range. In testing even with 5% Electrode Positive can provide enough cleaning to weld, while the other 95% of the arc energy can be put into heating the weld and providing penetration. The ability to adjust the balanced between the positive and negative cycles allows more penetration with less amps, narrower, less unsightly cleaning lines, and the ability to weld without a ball on the end of the tungsten. With the ability to weld without a ball on the tungsten, the arc stays more stable, and is focused more back into the weld.

The range on this unit is expressed as a percent of AC positive with the idea in mind that "full" AC cleaning is 100% electrode positive, and 0% electrode negative. Some brands express this with a reciprocal value of Electrode Negative. So what would be a "safe" 30% electrode positive setting on the Everlast, becomes a 70% electrode negative setting on other brands. Everlast, along with other brands has chosen this way to express this value since the amount of "cleaning" is always discussed and is a primary concern when welding aluminum. Increasing over 40% on AC balance will cause tungsten balling. There are legitimate reasons for welding over 40%, as in when the plate is heavily contaminated or oxidized, but if need over 40% cleaning, you will need to change to a larger tungsten that

will hold the point better. Once the tungsten begins to ball excessively, the arc will begin to become unsteady, or breakdown completely.

Signs of too little cleaning action while welding aluminum include soot, porosity, and dull looking (scummy) welds. A dedicated stainless steel brush and suitable aluminum cleaner such as acetone should be used before starting any aluminum weld to help break up the heaviest oxide layer so less Positive polarity is needed and better penetration can be achieved.

What is AC Balance?

See below for a graphic explanation of how the AC balance changes. Keep in mind the AC balance of this welder is a percent of positive polarity. A setting of 30%, would be 30% cleaning, and 70% penetration. A setting of 30% is actually a good starting point when welding in AC mode on this welder and should provide suitable results.

AC Wave Form Balanced at 50/50

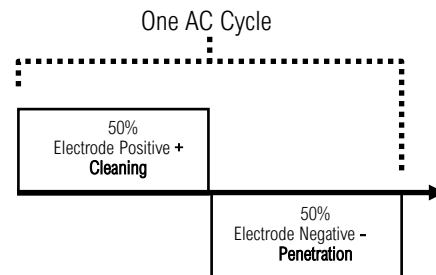

AC Wave Form Skewed to 30/70

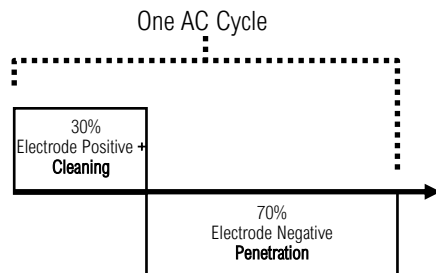

What is the effect of AC Balance?

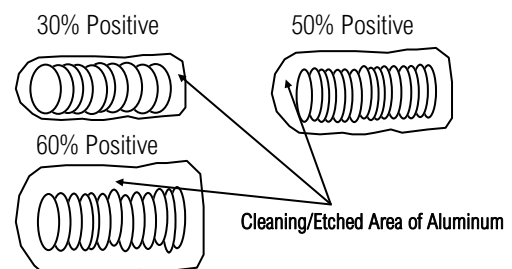

Symptoms of too much Positive Balance: Tungsten Balling, wide etched area, grainy weld.

Component Identification and Explanation

Explanation of Functions and Welding Terms

AC Frequency. AC frequency is the number of times per second that the AC completely cycles between positive and negative polarity. The number of cycles per second is referred to as Hertz (Hz) or frequency. Standard transformer welders typically have a fixed frequency of 60 Hz (North American market, other markets may be only 50 Hz). This is because of the standard input frequency from the power company is only 60hz(50Hz other regions). Transformer welders only have the ability to transform voltage, not the frequency. Whatever frequency is fed into the transformer, will be the frequency that is output at the torch. However, inverters welders have the ability to change AC frequency on the output side, despite the input frequency. This unit has the ability to control AC frequency from 20 to 250Hz. When operating at lower AC output frequency, the arc is wide and lazy, but puts more heat into the weld. Operating at higher frequency focuses the arc, and pinpoints the heat into a narrower area. Higher frequencies allow the arc to be better directed, but may slow forward travel speed.

What Does AC Frequency Control Do?

By increasing or decreasing frequency, the AC Frequency controls arc cone width, overall heat input, travel speed, and directability of the arc while welding in AC mode. See the illustration below for how AC frequency affects the weld. An initial setting of 100Hz to 120Hz is a good starting point for most general applications.

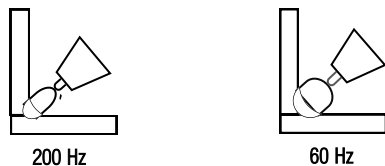

Arc Force. The arc force function only works in Stick mode. Arc force is used to offset the loss of overall wattage ($V \times A = W$) as arc length is shortened and voltage begins to drop while stick welding. It offsets the drop in voltage by injecting extra amps into the weld when voltage drops below 20V. This enables the amperage to react aggressively or mildly, depending upon settings, to prevent arc outages, and allowing the user to hold a tight arc and maintain better control.

DC. Direct Current. Used to weld Steel, Stainless Steel (Inox), Chrome Moly, Titanium, and more. Not used with Aluminum and Magnesium.

Down Slope. This is a function to be used with 2T/4T remote operation, not with the foot pedal. This timer controls the decrease of the amperage and provides a window to fill the crater as the puddle begins to cool before the arc terminates. This is not to be used with the foot pedal, or a delay, or sudden increase in amps at arc termination would result. If set with a long Down-Slope, and 4T is used, the switch can be toggled to abort the downslope cycle and return to

welding amps. Once the current has declined though, the next “click” of the torch switch will terminate the arc.

High Voltage Electronic HF Start. Depicted as HF start on the panel, this is a touchless type of start, but is the newer type HV electronic start. When HF start is selected, the user positions the torch 1/8” or less above the weld area and either presses the foot pedal or the torch switch and the arc will jump. This start is created by an electronically controlled HV system similar to the old HF point design but without the maintenance and arc start reliability issues associated with a point-gap HF system design. A high voltage, low amperage current is created which jumps from the Tungsten to the work piece when activated. Once the machine sends the HV impulse to the torch, the HV energy jumps, the welding arc will initiate after the HV

Do I need to adjust points on this welder?

The PowerTIG 200DV has been upgraded to a solid state HV start. This eliminates the point gap design of the older PowerTIG 200DV models. High Voltage (HV) starting is essentially the same as the traditional HF starting, however it differs in the fact this is an electronically generated arc start. This has been optimized for many different applications and allows a clean crisp start. For some applications where contaminated tungsten is common or where poor work clamp connections exist increased starting difficult may be experienced. In this case the unit can be adjusted for a longer start duration. This is accessible via a background menu. For accessing this menu, please page 34 of this manual for further instructions.

How Do I Perform an HV(HF) Start?

1. Place the point of the tungsten 1/8” or less over the work piece.
2. Press the torch trigger or foot pedal, whichever is connected, and the HV spark will be emitted. It may appear as small sparks or lighting if the arc doesn't start immediately.
3. Once continuity establishes, the welding arc will begin. You may begin to advanced the torch when a puddle forms. Maintain 1/8” height or less while welding.

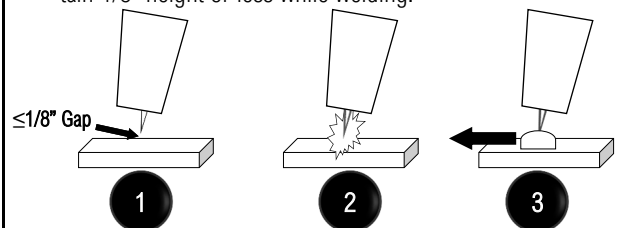

establishes a current path and the HV shuts off. On this unit if the HV stays on, but does not start an arc or an arc is not sensed, the unit will stop output of the HV after approximately 2 to 3 seconds. If this happens an error code “205” will be displayed temporarily, meaning the switch is either stuck closed, or the arc has been activated too long without an arc start. This is a safety feature as the simulated HV (HF) energy can affect surrounding electronic items.

Component Identification and Explanation

Explanation of Functions and Welding Terms

Lift Start. Lift start requires touchdown and lifting up of the Tungsten to start the Arc. It is usually used only with DC output since some contamination of the tungsten is possible. But it can also be used with AC where HV/HF energy is prohibited, such as in a hospital environment. *There are two types of Lift Start.* The first is a live lift start. This means the tungsten is always electrically live until the arc is started. When the tungsten is touched to the metal, continuity is sensed and the welder sends welding power as soon as the continuity is broken. This unit does not have this type of Lift Start. Some of our units have this type start, but it is not featured on this machine. If you need this type of start on a welder, contact Everlast for other product information. The other type of lift start is a "remote lift start". This is the type this unit has. It functions essentially the same except, the tungsten is not electrically live and the torch switch or foot pedal must be used to make the torch live. This is a safer form of lift start and helps prevent accidental starting of the arc. It also means that the start type can be used with the welder programming in 2T and 4T mode, or with the foot pedal.

Post Flow. Post Flow is the amount of time (in seconds) that the shielding gas flows after the arc is terminated. This is an important function. The flow of shielding gas after welding is stopped helps to 1) Cool the torch and tungsten and prevents oxidation of the tungsten as it cools. 2) Provide cooling and shielding while the weld puddle solidifies and cools. This helps to prevent the weld from

forming porosity and prevents oxidation of the weld as it cools. Post Flow should be increased at the Amperage increases. **For simple calculation, add one second of Post Flow for every 15 to 25 Amps used. At a minimum, 2 to 3 seconds should always be used.** To properly use Post Flow, the torch should be held in place over the weld after termination until the gas shuts off.

Pre Flow. Pre Flow is the amount of time (in seconds) that the shielding gas flows before the weld starts. It is very important that the Pre Flow be set for at least a short flow before any weld. The Pre-Flow not only purges the torch of any contamination, but it also establishes a protective envelope of shielding gas around the weld before the arc initializes. This protects the tungsten, and helps to establish an arc more quickly by surrounding the tungsten and work with more easily ionized gas so that arc starts are more efficient. It also allows time for the gas flow to stabilize before the arc is struck. When initializing the Pre Flow a "rush" of gas can often be heard just ahead of the arc strike. Then the gas flow will quieten down as the weld begins. This is normal. This rush of gas is caused by several things, but it is in part due to regulator attempting to regulate the sudden rush of gas. As it does this, extra gas may be consumed until the regulator has had time to react. The extra flow of gas may create turbulence around the weld. The Gas flow rate may also temporarily increase due to the back pressure "ballooning" of the gas lines. As the slightly swollen gas lines stabilize, extra gas is propelled as the solenoid opens relieving the back pressure. .3 to .7 seconds is usually enough to allow the "gas rush" to stabilize.

Pulse. The TIG pulse creates two amp values, a high and a low value that cycle back and forth between each other while welding. The upper amperage is called the "Welding Amps" (sometimes referred to as "Peak" current.) The lower amperage is called "TIG Pulse Amps" (sometimes called "background" or "base" current). Pulse has

How Do I Perform a Lift Start?

1. Rest the edge of the cup on the work piece so that the tungsten is slightly off the work. Press the trigger or foot pedal. Quickly rotate the tungsten to the work using the cup edge as a pivot.
2. A small spark may be noticed as it touches. Once the Tungsten touches, quickly and seamlessly rotate the cup back to draw an arc.
3. Raise the cup to establish the arc to 1/8" or less in height.
4. Allow the puddle to form and move the torch forward maintaining 1/8 or less height.

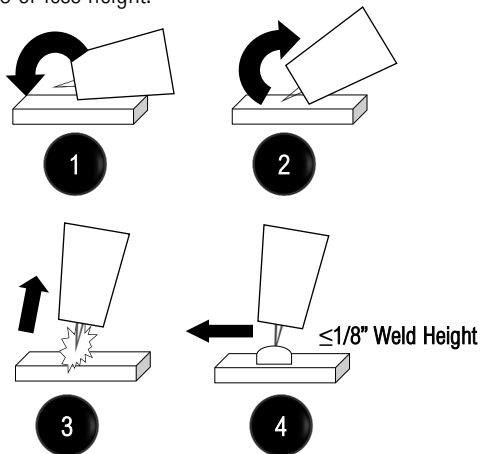

NOTICE:

The arc start will be delayed by the amount of time chosen for Pre Flow. If Pre Flow is set for 2 seconds, the arc will not start for 2 seconds. This is sometimes easy to forget, especially when tacking or "Bump" welding.

several uses and can be used to control arc directability, arc cone width, heat spread, penetration and even weld appearance. It is particularly useful on metals that are prone to structural deterioration or burn through. Pulse creates a lower Amp average, and "felt heat" by varying one or more of several adjustable parameters of the pulse. This welder features several adjustable parameters that affect Pulse operation:

1. **Pulse Amps (Base).** Base Amps is the low Amperage value of the pulse. When you adjust the base Amps in pulse mode, you are actually setting a ratio of base Amps to peak welding Amps.

Component Identification and Explanation

Explanation of Functions and Welding Terms

Base amps are expressed as a percentage of Peak welding Amps. So, when you set base amps, you are only setting it as a percentage, not the actual Amps. As you increase Peak welding Amperage through the use of the foot pedal, or the panel control, the pulse will maintain the same ratio of Base to Peak welding Amps, raising the base Amps automatically. To illustrate: Adjust the Peak (main welding) Amps, to 100. Set the base Amps to 50%. This will yield a 50 Amp value for the base Amps. The foot pedal controls both Peak welding Amperage and Base Pulse Amperage simultaneously, using the pre-set ratio.

- Pulse Frequency.** Pulse speed or frequency as it is referred to is measured in the standard unit "Hertz." Simply, it is the number of pulses per second that occur. Pulse frequency controls the arc constriction and also helps with heat management. A slower pulse frequency around 1 to 3 hertz gives the "stacked dime" appearance. At higher frequencies the "stacked" appearance will be lost while heat control is maximized.
- Pulse Time On (Balance).** Pulse Balance is the percentage (%) of time that the pulse stays in the TIG (Peak) pulse Amp stage of the cycle. Increasing the Pulse time-on will increase the duration the Peak Amp stage of the cycle which in turn will increase the heat and will increase penetration. Pulse Balance is also known in the industry as duty cycle. For welding purposes the term "Pulse Time On" is used here.

Setting up the pulse is not a process where a fixed adjustment procedure can be assigned or rigidly recommended. Changes to frequency, balance, and time will skew the final result. A slow pulse with a equal 50% pulse time on and somewhere around a 50-75% Pulse Base Amp setting is typically used to help with timing the addition of filler metal to the weld puddle. A higher pulse frequency level that is combined with variations in Pulse Time On and a narrow/wider ratio can be used to prevent burn through and speed up welding on thin materials. It can also help maintain a proper bead profile on a thin edge weld or prevent burn through on extremely thin metal. A fast pulse speed will make fine ripples in the weld while a slow pulse speed will give a much more coarse, but visually appealing result. There are limitless ways to adjust the pulse. Regardless of how you choose to adjust the pulse, always keep in mind, that the basic purpose of the pulse is to average the heat input while maintaining penetration and welding speed.

AC Pulse TIG operation is setup the same. Do not confuse AC cycling between EP and EN as pulse. It is not. You are still adjusting the amperage of the AC pulse, and skewing the balance and changing the frequency similarly to the DC pulse.

With the pulse turned on, you may notice the amp display reading at odd amperages, or at a value not set before welding. This is normal as the welder is attempting to average and sample the welding am-

perage in real time. Slower Pulse frequencies are more apt to display truer max and min Pulse Amp values. This randomizing/averaging happens because it would be impossible for the display to cycle between those values at the same pace of the pulse frequency. For example: If pulse frequency is at 100Hz, the display cannot change the readout 100 times a second to display both values. Even if it could cycle that fast, the display would not be readable.

Regulator. Controls the flow rate of the shielding gas at the cylinder.

Remote. Remote refers to the ability to control the weld cycle at a distance. For this welder, all forms of TIG welding, whether with Lift

Is There a Better Way to Understand Pulse?

Pulse is essentially a wave form created by the pulsing amperage. This wave form can be skewed, expanded, compressed, increased or decreased in magnitude. Each change in Amps, Pulse Time On Balance, and Frequency all affect average heat being put into the weld. The examples below attempt to explain the parts of the pulse and how each part of the pulse functions.

EXAMPLE 1

Peak Pulse Amps: 100 amps,
Base Amps: 50%
Pulse Time On: 50%
DC Pulse Frequency: 1 Hz

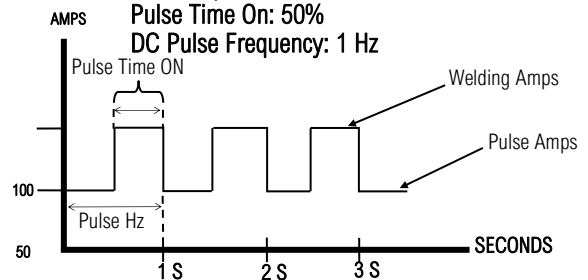

EXAMPLE 2

Peak Pulse Amps: 100 amps
Base Amps: 50%
Pulse Time On : 50%
DC Pulse Frequency: 25Hz

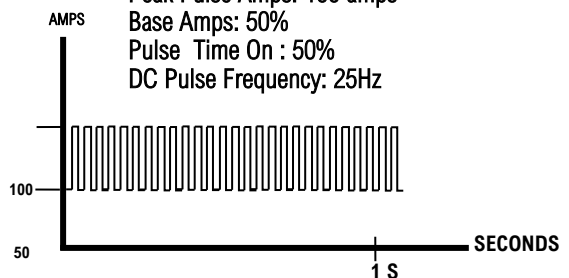

EXAMPLE 3

Peak Pulse Amps: 100 amps
Base Amps: 25%
Pulse Time On: 75%
DC Pulse Frequency: 3 Hz

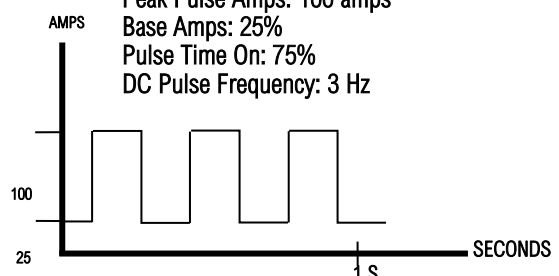

Component Identification and Explanation

Explanation of Functions and Welding Terms

Start or HV (HF) Start, require a remote to operate. A remote can be a foot pedal, torch switch, or torch mounted slider or Amptrol. All three start and end the arc as well as control other parts of the weld cycle to varying extents. The unit has three Remote settings to choose from. The first two, 2T and 4T, deal exclusively with torch switch operation. The third is pedal control.

Pedal mode is the most straight forward. Operation is quite simple. The maximum amperage is set on the panel. Then the foot pedal is used to start and stop the arc as well as vary the amperage from the minimum welding setting, up to the maximum welding setting selected on the panel. When used in pedal mode, only the Pre Flow and Post Flow should be adjusted. Down Slope should remain zeroed out, (set at the minimum allowed setting).

2T mode and 4T mode offer two modes used with the torch switch that is included with the TIG torch. This is used to control the torch cycle through preset functions of Pre/Post Flow, Up/Down Slope, Start/End Amps. Even though some of these functions are not adjustable on this unit, they do have “fixed” values in the weld cycle. In 2T mode, the torch switch is simply pressed and held to start the arc and cycle the preprogrammed settings. Once arc termination is desired, the switch is released. In 4T mode, the Torch trigger is held down to start the pre-flow and initiate the arc at the minimum Start Amperage allowed by the units programming (5 or 20 amps depending on whether you are operating in DC or AC). The switch is then released and the unit ramps immediately to the welding current. The weld is continued without the switch being pressed. Once the weld is nearing finish, the torch switch is once again pressed and held to down slope to the “End Amp” (non-adjustable) value. Then the torch is released to terminate the arc and begin post flow.

Shielding Gas. Shielding Gas is necessary while TIG welding. The shielding gas used for the TIG process is 100% Argon. Shielding gas protects the weld from oxidation by the atmosphere while the weld puddle is still molten. Gas flow rates are controlled by the sup-

NOTICE:

While using the foot pedal, and the optional slider switch, the welder's digital display will revert back to the minimum amp setting on the welder after the arc is terminated and it will not display maximum set amps. It will only display maximum set amps while the unit is being adjusted for amperage. While welding the display will read actual weld amperage. After 3-4 seconds the display will default back to the minimum amp reading. When using 2T or 4T control modes, the amps will register the maximum set amps until the arc is started. To see the maximum set amperage in the pedal mode without the arc on, simply make a small adjustment in the main adjustment knob while the Welding Amps light is lit. The unit will revert to the “setting” mode and display selected maximum amperage.

plied regulator. Too little gas flow will cause porosity, heavy scale and or oxidation. Too much gas flow is wasteful and can also create a turbulent flow, which can pull the atmosphere into the weld, creating oxidation.

Stick. In North America, this is the SMAW process (Shielded Metal Arc Welding) In other regions this is called MMA (Manual Metal Arc). Stick is an older term to refer to the stick like appearance of the welding electrodes (also known as welding rods). This is a versatile process and can be used in adverse conditions where TIG cannot. For welding, this unit is not recommended for use with E6010. However, E6011 may be used, but performance may be brand dependent. A short arc length should be used. A dragging motion is recommended and a higher arc force setting is recommended when welding with E6011. For best results with stick welding, Everlast recommends E7014 and E7018 for general purpose use and fabrication. Stainless rods and aluminum rods may also be used.

Welding Amps. This is the main Amperage control. When used in the context of Pulse, this is the “Peak” part of the pulse while the Pulse Amps is the “Base Amp” part of the pulse. Without Pulse, the

How Does 2T and 4T Work?

The torch switch has two possible modes of operation. The first is a “press and hold”. The second allows the switch to be released to weld, but offers separate motions to start and stop the arc. See below for how each function is activated by movements of the torch switch. Note that some of the functions listed below are not adjustable on this unit, but still play a part in how the 2T/4T functions in the weld cycle.

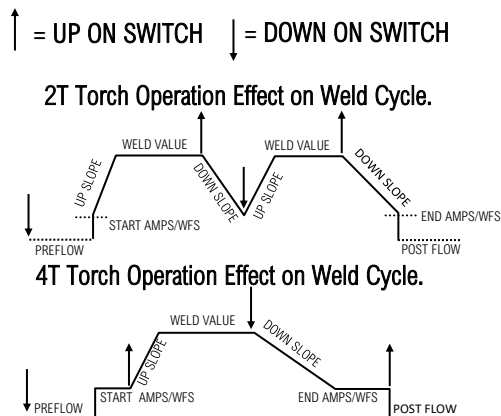

How Do I Start an Arc With Stick?

There are two basic types of arc starting methods used. The tapping motion allows pin point placement of the arc, while the scratch start method is similar to a match strike and is easier for beginners.

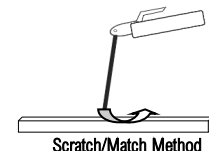
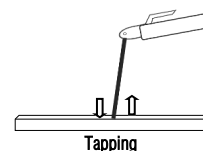

Component Identification and Explanation

Explanation of Functions and Welding Terms

main welding amps simply controls the Amperage of the welder.

Component Identification and Explanation

26 Series Air (Gas)-Cooled Welding Torch (Typical Type) Parts and Assembly.

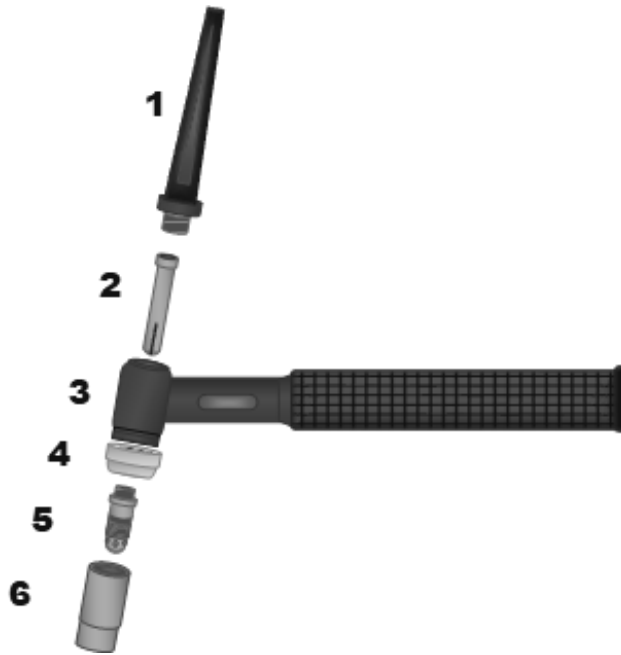

Typical Everlast and NOVA Torch Assembly (17,18, 26 Series)

(Some parts may not appear exactly the same but are equal in assembly order and type.)

Tungsten not included, but available in select Consumable Kits on the website at www.everlastwelders.com.

Consumables are standard sized for series 3 torches, and interchange with consumables made for similar torches with similar nomenclature.

#	Description	Size/Type	Part#	Alternate Ref.	Note
1	Back Cap	Long	NVA57Y04-3	57Y02	
1	Back Cap	Medium	NVA41V35-3	41V35	Or 300M
1	Back Cap	Short	NVA57Y04-3	57Y04	
2	Collet	.040"	NVA10N22-3	10N22	1.0mm
2	Collet	1/16"	NVA10N23-3	10N23	1.6mm
2	Collet	3/32"	NVA10N24-3	10N24	2.4mm
2	Collet	1/8"	NVA10N25-3	10N25	3.2mm
3	Torch Body/Handle	17,26, or 18	Call for App.		Varies by Type
4	Heat Shield	17/26/18	NVA-HS172618	Heat Shield	Interchanges with similar aftermarket
5	Collet Body	Universal one size fits 1/16" to 1/8"	Stock	Stock	Universal Collet Body and Collets supplied with original starter kit
5	Collet Body	.040"	NVA-10N30	10N30	1.0mm, match to collet size
5	Collet Body	1/16"	NVA-10N31	10N31	1.6mm, match to collet size
5	Collet Body	3/32"	NVA10N	10N32	2.4mm, match to collet size
5	Collet Body	1/8"	NVA10N28	10N28	3.2mm, match to collet size
6	Cup	4	NVA-10N50-3	10N50	Standard, non gas lens 1/4"
6	Cup	5	NVA-10N49-3	10N49	Standard, non gas lens 5/16"
6	Cup	6	NVA-10N48-3	10N48	Standard, non gas lens 3/8"
6	Cup	7	NVA-10N47	10N47	Standard, non gas lens 7/16"
6	Cup	8	NVA-10N46-3	10N46	Standard, non gas lens 1/2"

Component Identification and Explanation

7 PIN CONNECTOR FOR 10K or 22K Ω FOOT PEDAL

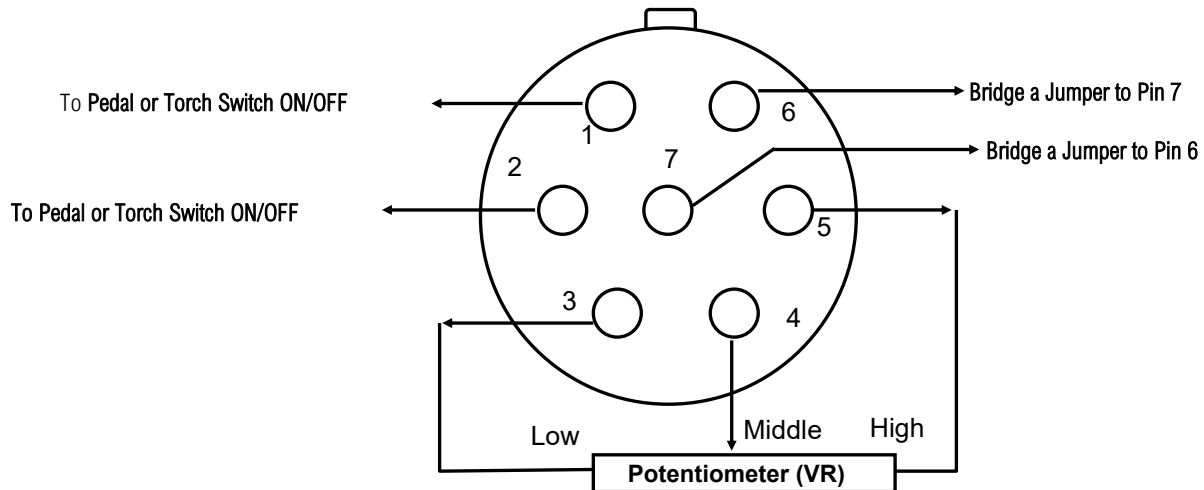

Foot Pedal (10k-22k Ω)

Note: This unit is designed to accept several different Ohm values, including the older 47K (50K) Ohm pedal without significantly affecting operation. The pinout of the pedal is unchanged in either case.

Troubleshooting

Error Codes

TROUBLE CODE WITH WARNING LIGHT/UNIT STOPS WELDING BUT IS TURNED ON.	DIAGNOSIS
01	OVER OR UNDER VOLTAGE. Check power input cable for length/size, check input voltage. Running on poor quality power supply or dirty power from generator.
02	OVER TEMPERATURE/ DUTY CYCLE EXCEEDED. Allow unit to rest for 15 minutes. Check for obstacles, clean welder, and heat sinks. Make sure unit is unplugged for 30 minutes before opening up for cleaning.
04	OVER CURRENT. Check to make sure input power cable is correct length and size. Internal unit fault or low input voltage. Possible issue running on generator with dirty power. Identify cause, plug directly into the receptacle. Cycle the switch one time. If the code does not clear, call Everlast Tech Support.
05	TORCH SWITCH IS STUCK CLOSED. This simply means that the arc has been trying to start and the HV start has been cycled on for too long. If this does not clear after releasing the foot pedal, turn off welder immediately and check torch switch for stuck contact. Check foot pedal for complete return or stuck micro-switch. Do not hold down the switch or pedal without attempting to strike an arc. Doing so for more than 2 seconds without starting will cause this error code. If this does not correct the issue, increase start time found in back ground menu.
OTHER	CONTACT EVERLAST

Troubleshooting

Common Welding Issues

NO.	Trouble	Possible Cause	Solution
1.	Unit is switched on, but the power light isn't on.	Switch damaged. Service Breaker/ Input Line Damaged	Check. Replace.
2.	After welding machine is overheating and the fan does not work.	Fan damaged. Fan connector plus is loose	Replace. Check. Reinstall.
2a.	After arc is struck fan does not come on.	Fan control circuit damaged	Contact Everlast for repair.
3.	When switch/pedal is pressed, no gas flows.	Empty Cylinder/ Closed Valve. Regulator Faulty/shut off. Solenoid Dirty/Stuck Shut Damaged PCB	Check. Replace/Open Check, Open Check. Clean or Replace. (Contact Everlast Technical Support) Contact Everlast Technical Support
4.	Intermittent, wandering arc.	Work Clamp not connected directly to part being welded. Work Clamp worn/damaged Torch height too high.	Reconnect. Replace. Reduce TIG torch height to under 1/8". Drag Welding Rod (Stick)
5.	Arc won't start.	HV misadjusted, wrong polarity, wrong AC balance (for AC only). AC frequency is too low (for AC only) Tungsten is balled, contaminated or wrong type.	Check and adjust HV setting. Select negative terminal for torch,. Set AC balance to 30%. Use 2% blue lanthanated Tungsten sharpened to a point. Do not ball or use if tungsten has been dipped without resharping.
6.	Tungsten is rapidly consumed.	Inadequate gas flow. Too small of tungsten. Wrong shielding gas. Using green tungsten. Wrong polarity. Possible contamination of shielding gas from gas supplier.	Check gas flow. Check for Leaks throughout system/regulator/tank. Check for 100% Argon. Use Lanthanated 2% or any other type besides Green (Pure) or Zirconiated. Put torch in Negative.
7.	Tungsten is contaminated, arc changes to a green color.	Tungsten is dipping into weld. Too long of stick-out. Tungsten is melting.	Check and adjust stick out to 1/8 inch. Reduce stick-out to less than 1/4". Reduce amperage or increase tungsten size.
8.	Porosity of the Weld. Discolored weld color. Tungsten is discolored.	Low flow rate of shielding gas. High flow rate of shielding gas. Tungsten stick-out is too far. Too short of post flow period. Wrong TIG cup size. Possible gas leaks internally or externally due to loose fittings. Base metal is contaminated with dirt or grease.	Increase flow rate on regulator. Check for kinks in tubing. Increase post-flow time. Reduce stick-out to less than 1/4". Increase cup size, or use gas lens. Clean metal thoroughly with approved metal cleaner, or use acetone and a rag to clean metal
9.	Weld quality is poor. Weld is dirty/oxidized, or porous.	Drafty conditions. The welder is located on the workpiece and is blowing gas off due to fan activity. Solenoid is sticking. Too short of pre-flow or post-flow	Eliminate drafts. Move welder. Check if there is sufficient shielding gas left in tank. Check gas flow. Adjust for higher flow of gas. Listen for audible click of gas solenoid. If no click is heard, then contact Everlast Support. Clean weld properly. Increase pre flow or post flow.
10.	Unstable Arc.	Poorly ground or shaped tungsten. Bad work clamp connection. Metal is indirectly connected through table or other item.	Regrind to proper point. Wrong polarity. Place torch in DC negative (-). Connect work clamp directly to item being welded.
11.	AC TIG will not weld properly.	Wrong polarity. Work clamp is not connected direct to work. Balled Tungsten AC Balance too high AC Frequency too low Contaminated Gas	Check and change immediately. TIG torch is always negative. Put clamp direct to work. Sharpen Tungsten. Do not use Ball Set for approximately 30% Increase to 50 Hz or higher Source new cylinder or new supplier
12.	Other.		Contact Everlast

Maintenance/ Adjustment

Arc Start Time Adjustment



The arc start time adjustment is designed to increase or decrease the arc start cycle duration. To adjust this function, the background menu must be accessed and the time increased/decreased. It is suggested the time needed should only be long enough to create a successful arc start and transfer. Excessively long times are not needed and may contribute to wear on the circuit. To access the menu and adjust the setting:

1. Simultaneously press and hold the Pulse and AC/DC green arrow buttons (1 and 2). The start time will display.
2. Use the Amp adjustment knob to increase or decrease the value.
3. The unit will automatically exit after no input is made within a few seconds.
4. Test for arc starting reliability and readjust if necessary.

Regular Cleaning and Inspection.

Every three to four months, you should clean and inspect the internal parts of the unit. Excessive build up of material, like metal dust, on boards can cause malfunctions. This is important to keeping your welder running for many years into the future. **It is important to note that cleaning doesn't void your warranty, but rather ensures it!** Keep your welder covered when not in use. You can purchase a cover for your welder direct from Everlast.

CAUTION! When blowing out with dry compressed air, be sure to use safety glasses.

To Clean out your unit:

1. Unplug the unit for 20 minutes before beginning.
2. Unscrew all screws in rear plastic panel and remove.
3. Unscrew all screws in metal cover and remove cover carefully, avoiding pinching any wires close to the cover.
4. Blow out gently with dry compressed air.
5. Inspect all circuits and connections. If possible reseat connectors and blow out connections while doing it.
6. Reassemble.
7. Document and report any anomalies or areas of concern to Everlast Tech Support as soon as possible.

