

EVERLAST

POWER MTS 251Si

A Digitally-Controlled, Multi-Process MIG/TIG/Stick Welder



Operator's Manual for the PowerMTS 251Si Safety, Setup and General Use Guide

everlastwelders.com

Rev. 2 0 110712-24

Specifications and Accessories subject to change without notice.



1-877-755-9353

329 Littlefield Ave. South San Francisco, CA 94080 USA

Table of Contents

Section.....	Page
Letter to the Customer	3
Everlast Contact Information.....	4
Safety Precautions.....	5
Introduction and Specifications.....	9
Overview of Parameters and Specifications.....	9
Technical Parameters.....	10
General Description, Purpose and Features.....	11
Set Up Guide and Component Identification.....	12
Suggested Settings.....	12
Connections and Polarity.....	14
General Polarity and Amp Recommendations....	15
Installing The Wire Spool.....	17
Front View Main Panel.....	18
Front Panel Item Description and Explanation....	19
Side View	26
Side View Item Description and Explanation.....	27
Rear View Back Panel.....	28
Rear Panel Item Description and Explanation....	29
Basic Theory and Function.....	30
Basic MIG Operation.....	30
Pulse MIG Operation.....	37
Pulse MIG Work Sheets.....	45
Stick Operation.....	51
Special Notes Concerning Operation.....	52
Basic TIG Operation.....	55
TIG Arc Starting.....	57
Tungsten Preparation.....	58
Pulse TIG Operation.....	59
TIG Work Sheets.....	61
25 Series MIG Torch.....	64
25 Series Consumables.....	65
24 Series MIG Torch.....	66
24 Series Consumables.....	67
26 Series TIG Torch.....	68
Trouble Shooting Guide.....	69
Error Codes.....	71

Dear Customer,

THANKS! You had a choice, and you bought an Everlast product. We appreciate you as a valued customer and hope that you will enjoy years of use from your welder.

Please go directly to the Everlast website to register your unit and receive your warranty information. Your unit registration is important should any information such as product updates or recalls be issued. It is also important so that we may track your satisfaction with Everlast products and services. If you are unable to register by website, contact Everlast directly through the sales department at the main customer service number in your country. Your unit's warranty will be registered and in full effect. Keep all information regarding your purchase, including date of purchase and receipt. **In the event of a problem with your unit or other issue you must contact technical support before your welder can be a candidate for warranty service and returned. An over-the-phone review/diagnosis must be performed BEFORE a RMA will be issued or before the unit can be sent in for service.**

Please read the warranty statement published online and other important information found on the Everlast website of the division located in or nearest to your country. This includes the terms of the purchase and warranty procedure. Print it for your records and become familiar of its terms and conditions. Please note that Guns, accessories and torches are covered under a separate, shorter warranty. Please be sure you visit the website and are familiar with all the warranty terms before you call for service.

Everlast offers full technical support, in several different forms. We have online support available through email, and a welding support forum designed for our customers and non-customers to interact with each other. Technical advisors are active on the forum daily. We also divide our support into two divisions: technical and welding performance. Should you have an issue or question concerning your unit, please contact performance/technical support available through the main company headquarters available in your country. This support is free to all Everlast customers. For best service call the appropriate support line and follow up with an email, especially during weekends, holidays or any off hours when you cannot reach a live person. In the event you do not reach a live person, leave a message and your call will normally be returned within 24 hours, except for weekends and holidays. Also, for quick answers to your basic questions, join the company owned forum available through the website. You'll find knowledgeable staff available to answer your questions. You also may find a topic that already addresses your question at <http://www.everlastgenerators.com/forums/>. Should you need to call or write, always know your model name, purchase date and welder manufacturing inspection date. This will assure the quick and accurate customer service. **REMEMBER: Be as specific and informed as possible. Technical and performance advisors rely upon you to carefully describe the conditions and circumstances of your problem or question. Take notes of any issues as best you can. You may be asked many questions by the advisors to clarify problems or issues that may seem very basic. However, diagnosis procedures MUST be followed to begin the warranty process. Advisors can't assume anything (even with experienced users) and must cover all aspects to properly diagnose the problem. Depending upon your issue, it is advisable to have basic tools handy such as screwdrivers, wrenches, pliers, and even an inexpensive test meter with volt/ohm functions before you call.**

Let us know how we may be of service to you should you have any questions.

Sincerely,

Everlast Customer Service



Serial number: _____
Model number: _____
Date of Purchase: _____

Contact Information

Everlast US:
Everlast consumer satisfaction email: sales@everlastwelders.com
Everlast Website: everlastwelders.com
Everlast Technical Support: support@everlastwelders.com
Everlast Support Forum: http://www.everlastgenerators.com/forums/index.php
Main toll free number: **1-877-755 WELD (9353) 9am—5pm PST M-F**
11am-4pm PST Sat.

FAX: 1-650-588-8817

Everlast Canada:
Everlast consumer satisfaction email: sales@everlastwelders.ca
Everlast Website: everlastwelders.ca
Everlast Technical Support: sales@everlastwelders.ca
Telephone: 905-630-8246 9am-4:30pm EST M-F

Everlast Australia:
Sydney: 5A Karloo Parade Newport NSW 2106
(02) 9999 2949
Port Macquarie: 2B Pandorea Place Port Macquarie
(02) 6584 2037
After hours support: **0410 661 334**
Everlast Technical Support: support@pickproducts.com

OTHER (Please record here for your records):

Safety Precautions

Everlast is dedicated to providing you with the best possible equipment and service to meet the demands of the welding applications that you have. We want to go beyond delivering a satisfactory product to you. That is the reason we offer technical support to assist you with your needs should an occasion occur. With proper use and care your product should deliver years of trouble free service.



Safe operation and proper maintenance is your responsibility.

We have compiled this operator's manual to instruct you in basic safety, operation and maintenance of your Everlast product to give you the best possible experience. Overall, welding requires experience and common sense to obtain the best results in the safest manner. As thorough as this welding manual may be, it cannot substitute for the time, instruction and knowledge level required to learn how to weld. Exercise extreme caution and care in all activities related to welding or cutting. Your safety, health and even life depends upon it. While an accident is never planned, preventing an accident requires careful planning.

Please read this manual carefully before you operate your Everlast unit. Do not operate this welder until you are thoroughly familiar with its safe and proper operation. If you feel you need more information please contact Everlast.

The warranty does not cover improper use, maintenance or consumables. Accessories such as guns, torches regulators, foot pedals etc. are not covered in the unit warranty. They are covered under a separate warranty. **Do not attempt to alter or defeat any piece or part of your unit, particularly any safety device.** Keep all shields and covers in place during unit operation should an unlikely failure of internal components result in the possible presence of sparks and explosions. If a failure occurs, discontinue further use until malfunctioning parts or accessories have been repaired or replaced by qualified personnel.



Note on High Frequency electromagnetic disturbances:

Certain welding and cutting processes generate High Frequency (HF) waves. These waves may disturb sensitive electronic equipment such as televisions, radios, computers, cell phones, and related equipment. High Frequency may also interfere with fluorescent lights. Consult with an electrician if disturbance is noted. Sometimes, improper wire routing or poor shielding may be the cause.



HF can interfere with pacemakers. See EMF warnings in following safety section for further information. Always consult your physician before entering an area known to have welding or cutting equipment if you have a pacemaker.

Safety Precautions



These safety precautions are for protection of your safety and health. Failure to follow these guidelines may result in serious injury or death. Be careful to read and follow all cautions and warnings. Protect yourself and others from danger and injury.



Welding and cutting processes produce high levels of ultraviolet (UV) radiation that can cause severe skin burn and damage. There are other potential hazards involved with welding such as severe burns and respiratory related illnesses. Therefore observe the following to minimize potential accidents and injury:



Use appropriate safety glasses with wrap around shields while in the work area, even under welding helmets to protect your eyes from flying sparks and debris. When chipping slag or grinding, goggles and face shields may be required.



When welding or cutting, always use an approved shielding device, with the correct shade of filter installed. Always use a welding helmet in good condition. Discard any broken or cracked filters or helmets. Using broken or cracked filters or helmets can cause severe eye injury and burn. Filter shades of no less than shade 5 for cutting and no less than shade 9 for welding are highly recommended. Shades greater than 9 may be required for high amperage welds. Keep filter lenses clean and clear for maximum visibility. It is also advisable to consult with your eye doctor should you wear contacts for corrective vision before you wear them while welding.



Do not allow personnel to watch or observe the welding or cutting operation unless fully protected by a filter screen, protective curtains or equivalent protective equipment. If no protection is available, exclude them from the work area. Even brief exposure to the rays from the welding arc can damage unprotected eyes.



Always wear hearing protection because welding and cutting can be extremely noisy. Ear protection is necessary to prevent hearing loss. Even prolonged low levels of noise has been known to create long term hearing damage. Hearing protection also further protects against hot sparks and debris from entering the ear canal and doing harm.



Always wear personal protective clothing. Flame proof clothing is required at all times. Sparks and hot metal can lodge in pockets, hems and cuffs. Make sure loose clothing is tucked in neatly. Leather aprons and jackets are recommended. Suitable welding jackets and coats may be purchased made from fire proof material from welding supply stores. Discard any burned or frayed clothing. Keep clothing away from oil, grease and flammable liquids.



Leather boots or steel toed leather boots with rubber bottoms are required for adequate foot protection. Canvas, polyester and other man made materials often found in shoes will either burn or melt. Rubber or other non conductive soles are necessary to help protect from electrical shock.



Flame proof and insulated gauntlet gloves are required whether welding or cutting or handling metal. Simple work gloves for the garden or chore work are not sufficient. Gauntlet type welding gloves are available from your local welding supply companies. Never attempt to weld with out gloves. Welding with out gloves can result in serious burns and electrical shock. If your hand or body parts comes into contact with the arc of a plasma cutter or welder, instant and serious burns will occur. **Proper hand protection is required at all times when working with welding or cutting machines!**



This welder contains moving parts that can result in injury. Keep hands, fingers, hair, and loose clothing away from the wire feeding mechanisms and fans while unit is switched on and in use. Do not attempt to defeat any safety feature. Always operate unit with guard in place on the wire feeder.

Safety Precautions



WARNING! Persons with pacemakers should not weld, cut or be in the welding area until they consult with their physician. Some pacemakers are sensitive to EMF radiation and could severely malfunction while welding or while being in the vicinity of someone welding. *Serious injury or death may occur!*



Welding and plasma cutting processes generate electro-magnetic fields and radiation. While the effects of EMF radiation are not known, it is suspected that there may be some harm from long term exposure to electromagnetic fields. Therefore, certain precautions should be taken to minimize exposure:

- Lay welding leads and lines neatly away from the body.
- Never coil cables around the body.
- Secure cables with tape if necessary to keep from the body.
- Keep all cables and leads on the same side the body.
- Never stand between cables or leads.
- Keep as far away from the power source (welder) as possible while welding.
- Never stand between the ground clamp and the torch.
- Keep the ground clamp grounded as close to the weld or cut as possible.



Welding and cutting processes pose certain inhalation risks. Be sure to follow any guidelines from your chosen consumable and electrode suppliers regarding possible need for respiratory equipment while welding or cutting. Always weld with adequate ventilation. Never weld in closed rooms or confined spaces. Fumes and gases released while welding or cutting may be poisonous. Take precautions at all times.

Any burning of the eyes, nose or throat are signs that you need to increase ventilation.

- Stop immediately and relocate work if necessary until adequate ventilation is obtained.
- Stop work completely and seek medical help if irritation and discomfort persists.



WARNING! Do not weld on galvanized steel, stainless steel, beryllium, titanium, copper, cadmium, lead or zinc without proper respiratory equipment and or ventilation.



WARNING! This product when used for welding or cutting produces fumes and gases which contains chemicals known to the State of California to cause birth defects and in some cases cancer.

(California Safety and Health Code §25249.5 *et seq.*)



WARNING! Do not weld or cut around Chlorinated solvents or degreasing areas. Release of Phosgene gas can be deadly. Consider all chemicals to have potential deadly results if welded on or near metal containing residual amounts of chemicals.



Keep all cylinders upright and chained to a wall or appropriate holding pen. Certain regulations regarding high pressure cylinders can be obtained from OSHA or local regulatory agency. Consult also with your welding supply company in your area for further recommendations. The regulatory changes are frequent so keep informed.



All cylinders are a potential explosion hazard. When not in use, keep capped and closed. Store chained so that overturn is not likely. Transporting cylinders incorrectly can lead to an explosion. Do not attempt to adapt regulators to fit cylinders. Do not use faulty regulators. Do not allow cylinders to come into contact with work piece or work. Do not weld or strike arcs on cylinders. Keep cylinders away from direct heat, flame and sparks.

Safety Precautions



WARNING! Electrical shock can kill. Make sure all electrical equipment is properly grounded. Do not use frayed, cut or otherwise damaged cables and leads. Do not stand, lean or rest on ground clamp. Do not stand in water or damp areas while welding or cutting. Keep work surface dry. Do not use welder or plasma cutter in the rain or in extremely humid conditions. Use dry rubber soled shoes and dry gloves when welding or cutting to insulate against electrical shock. Turn machine on or off only with gloved hand. Keep all parts of the body insulated from work, and work tables. Keep away from direct contact with skin against work. If tight or close quarters necessitates standing or resting on work piece, insulate with dry boards and rubber mats designed to insulate the body from direct contact.



All work cables, leads, and hoses pose trip hazards. Be aware of their location and make sure all personnel in area are advised of their location. Taping or securing cables with appropriate restraints can help reduce trips and falls.



WARNING! Fire and explosions are real risks while welding or cutting. Always keep fire extinguishers close by and additionally a water hose or bucket of sand. Periodically check work area for smoldering embers or smoke. It is a good idea to have someone help watch for possible fires while you are welding. Sparks and hot metal may travel a long distance. They may go into cracks in walls and floors and start a fire that would not be immediately visible. Here are some things you can do to reduce the possibility of fire or explosion:

- Keep all combustible materials including rags and spare clothing away from area.
- Keep all flammable fuels and liquids stored separately from work area.
- Visually inspect work area when job is completed for the slightest traces of smoke or embers.
- If welding or cutting outside, make sure you are in a cleared off area, free from dry tender and debris that might start a forest or grass fire.
- Do not weld on tanks, drums or barrels that are closed, pressurized or anything that held flammable liquid or material.



Metal is hot after welding or cutting! Always use gloves and or tongs when handling hot pieces of metal. Remember to place hot metal on fire-proof surfaces after handling. Serious burns and injury can result if material is improperly handled.



WARNING! Faulty or poorly maintained equipment can cause injury or death. Proper maintenance is your responsibility. Make sure all equipment is properly maintained and serviced by qualified personnel. Do not abuse or misuse equipment.



Keep all covers in place. A faulty machine may shoot sparks or may have exploding parts. Touching uncovered parts inside machine can cause discharge of high amounts of electricity. **Do not allow employees to operate poorly serviced equipment.** Always check condition of equipment thoroughly before start up. Disconnect unit from power source before any service attempt is made and for long term storage or electrical storms.



Further information can be obtained from The American Welding Society (AWS) that relates directly to safe welding and plasma cutting. Additionally, your local welding supply company may have additional pamphlets available concerning their products. Do not operate machinery until you are comfortable with proper operation and are able to assume inherent risks of cutting or welding.

Overview of Parameters and Features*



Power i-MIG 251Si**	
MIG/TIG/Stick Amp Range	120V: MIG 30-150A/ TIG 10-150A/ Stick 10-120A 240V: MIG 30-250A/ TIG 10-250A/ Stick 10-200A
Volt Adjustment Range MIG	120V: 15.5-22V 240V: 15.5-30V
MIG Wire Feed Speed	120V: 60-400 (5-10 m/min) 240V: 60 to 600 IPM (.5-15 m/min)
Input Voltage	120-240V Single phase (208V permissible)
Welder Type	Digitally controlled, IGBT inverter type with CV Pulse MIG , Pulse TIG, CC Stick functions.
Wire Roll Size and Diameter	.023”-.062” wire diameters possible with optional drive rolls. 12” diameter roll (Up to 44 lbs.); 8” adapter available (10-12 lbs.); 4” Diameter NOT SUPPORTED
Pre/Post Flow Control MIG/TIG	MIG: (Pre) 0-10 Seconds/ (Post) 0-10 Seconds; TIG (Pre) 0-10 Seconds/ (Post) 0-10 Seconds
Up/Down Slope of MIG Volts/ TIG Amps	MIG: 0-1 Second; TIG: 0-10 Seconds
Synergic MIG	Synergic MIG function for wires from .023” to .045” in diameter, with mild steel, stainless and Aluminum settings. Synergic feature operates via speed control on MTS version of Spool gun as well.
MIG Burn Back Timer Control	0-2 seconds
Inductance/Arc Force Control	0-100%
MIG/TIG Pulse Frequency	MIG: 10-250 Hz; TIG: .5-500Hz
Base MIG Volts/Pulse TIG Amps	MIG: 10-100% of Peak Volts; TIG: 3-95% of Peak Amps
Pulse MIG/TIG Time On/Balance	MIG 10-90%; TIG 5-95%
Memory	Saves up to 9 programs.
MIG Burn Back Timer	0-2 Seconds
Stick Hot Start Timer	0-2 Seconds
Stick Hot Start Intensity Control	0-100% over set amperage
Stick E6010 Capability	Not recommended, however E6011 may provide a more stable arc.
Power Cable Length	9.5 ft. (3m)
Accessories	24 Series MIG torch (some units, 25 Series) torch 9.5 ft. (3m), Work clamp with cable 9.5 ft. (3m) 300 A Stick Torch with cable (3m), Floating ball type regulator.

*See next page for complete electrical and technical data.

**Specifications subject to change without notice.

Section 1

Introduction and Specifications

EVERLAST POWERMTS 251Si		MODEL: PowerMTS 251Si		Serial No.				
		EN/ IEC60974.1						
		240V; DC: 30-250A; 15.5-26.5V			120V; DC: 30-150A; 15.5-21.5V			
		X	40%	60%	100%	40%	60%	100%
	U_0 V 60V	I2	250A	200A	160A	150A	120A	90A
		U2	26.5V	24V	22V	21.5V	20V	18.5V
		240V; DC: 10-250A; 10.4-20V			120V; DC: 10-150A; 10.4-16V			
		X	40%	60%	100%	40%	60%	100%
	U_0 V 60V	I2	250A	200A	160A	150A	120A	90A
		U2	20V	18V	16.4V	16V	14.8V	13.6V
		240V; DC: 10-200A; 20.4-28V			120V; DC 10-120A; 20.4V-24.8V			
		X	40%	60%	100%	40%	60%	100%
	U_0 V 60V	I2	200A	160A	130A	120A	95A	70A
		U2	28V	26V	25.2V	24.8V	23.8V	22.8V
 1~ 50/60 Hz	U_1 120-240V	120V I_{1MAX} : 36A I_{1EFF} 22.8A 240V I_{1MAX} : 37A I_{1EFF} 23.2A						
PROTECTION CLASS IP21S	COOLING METHOD: DUAL, FULL-TIME FAN		INSULATION: F		WIRE SPEED: 240V: 60*-600 IPM 120V: 60*-400 IPM			

*60 IPM is based on minimum useable feed rate.

NOTE: Environment, Maintenance and Safety: Keep this welder at least 12 inches away from all objects for proper cooling. Do not exceed 40° C in environment or duty cycle will be reduced. Regularly inspect and clean the welder and circuitry on a monthly basis with dry compressed air. Remove the covers only after the unit has been turned off and unplugged for 30 minutes to discharge the capacitors and to prevent the possibility of electrocution. Do not grind or direct sparks near the welder to prevent damage to the panel face and internal components. Damage of this nature is not covered by the warranty.

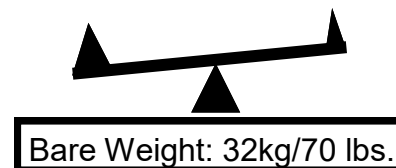

General Description, Purpose and Features. The Power MTS 211Si multi-process unit features an industry first High Frequency Start TIG design with incorporated gas solenoid for compact MTS-type welders. The compact stature of the PowerMTS 21Si features faithful IGBT power components and a simplified digitally controlled inverter design. The output of this unit is DC only for all processes. However, the spool gun capability of this unit allows the user to weld aluminum in MIG mode. The optional PowerSpool 200N-MTS gun is perfectly suited to this welder and is a good choice for welding aluminum. The PowerMTS 251Si also features a synergic function designed for non-pulse MIG operation, as well as full manual control. This welder does not have the traditional bulk of an undercarriage which is normally associated with multi-process welders of this range of capability, making it one of the most portable MIG/TIG/Stick welder in its class. In addition, the welder can accommodate full size rolls of MIG wire up to 12" in diameter (up to 44 lbs. typically). A wire spool adapter is available which will allow the unit to accept 8" spools. Although after-market 4" spool adapters can be purchased from many after-market suppliers, Everlast does not supply a 4" adapter for the machine. If 4" rolls are typical of your pattern of use, consider purchasing a spool gun which is ideal for this type application. The welder is capable of storing up to 9 programs for rapid setup and recall of favorite settings. This is helpful when storing favorite pulse programs. The unit also features a heavy-duty wire feeding mechanism with 4 driven drive rolls for maximum wire feeding capability. The multi-process aspect of this welder features additional welding processes which include DC TIG and Stick. The TIG process also features an industry first for MIG/TIG/Stick welders: a fully adjustable TIG Pulse setting, which allows the unit to pulse up to 500 times a second between two selected amp values. The TIG process also features High Frequency (HF) start (which is another industry first) to allow contactless starting of the TIG arc. The PowerMTS 251Si is the first unit in the industry to feature out-the-front controls for TIG, which also includes a solenoid controlled gas connection. See below for additional summary of features:

- 1) **GMAW Process (MIG).** The digitally controlled MIG components precisely control arc functions and give real-time feed back about the welding output parameters. As already mentioned, the welder is also spool gun (gun optional) ready for economical welding of Stainless and Aluminum wires if needed. The spool gun will function in all MIG modes and is a good solution when considering welding aluminum with MIG. The single pulse MIG design also further expands the capability of the welder. The welder can also be used with the flux core wire when equipped with optional flux core drive wheels. However, when used in synergic mode, Flux-Core operation will not be optimized, though the programmed ratio can be reset to function as desired and saved for future use.
- 2) **GTAW (TIG).** The TIG mode of the welder is DC output which is suitable for welding all metals except aluminum and magnesium. It includes a high frequency start and a lift start function to give the operator maximum flexibility welding in areas that are restrict HF use. All connections are provided on the front of the panel. No install kits are necessary to make the unit TIG ready. A gas solenoid is used to automatically control gas flow when the arc is started and stopped according to the time set on the panel. A foot pedal or torch switch is used to control the TIG function. The pedal controls the amps when plugged in. Similarly, the torch switch provided with the TIG torch can be used to control the sequencer that is used to set gas flow, amp and slope parameters. The unit is ready to TIG weld (with the exception of Tungsten and shielding gas) when it arrives. Additional TIG consumable kits can be purchased from Everlast which include stubby consumables or gas lens kits with Tungsten in the kit.
- 3) **SMAW (Stick).** In stick mode the welder delivers a smooth DC low spatter arc. Professional, high-quality welds are obtainable with E7018, 7014, 309L, 316L, 6011 and many other similar rods that are designed for use with any DC stick welder. This unit is not specifically optimized for welding E6010. Customers considering using the unit for serious E6010 use should consider other welder alternatives for use with cellulosic rods like the E6010 rod. The Stick mode also features adjustable hot start time and hot start intensity controls which are designed to help reduce sticking during arc starts while simultaneously reducing porosity or inclusions during arc initiation.
- 4) **Stick Arc Force Control.** The arc force control adjusts the quality and feel of the welding arc. It does so by modifying the volt/amp curve. As the voltage drops below approximately 20 volts when the arc gap length is shortened, the unit reacts by automatically boosting the amps over the original Amp setting. This helps to prevent the rod from sticking and helps keep the arc going as arc voltage falls. This action also boots penetration and can be

- used to change the way the arc feels and acts.
- 5) **Burn Back Control.** Burn back control is used to control the length of the wire stick-out after the trigger is released. It helps to prevent the welding wire from sticking in the coalescing weld puddle after the arc is terminated and saves the user from having to trim the wire before restarting the arc.
 - 6) **Synergic MIG Mode.** Synergic mode may be engaged to simplify welder setup and adjustment. This mode will allow the customer to input basic parameters and the machine will automatically set the wire feed speed (amps) and voltage based off of the user input. The unit's programming is easily overridden and the welder will remember the new ratio of voltage to wire feed setting during the active welding session until the process is changed, or until the Synergic mode is deselected. The machine has three synergic modes, one for standard MIG operation, one for standard Spool gun operation and one for standard push-pull gun operation.
 - 7) **Pulse MIG Mode.** Pulse MIG operation is designed to help the user achieve several key goals while welding. Most often, the pulse MIG mode is employed as a modification of the Pulse process using a different blend of gas ($\leq 10\%$ CO₂ typically, but as high as 20% CO₂), than standard 75/25 Ar/CO₂ mix used in short circuit steel. The use of Pulse spray is helpful for welding **out-of-position** (positions other than flat/down hand welding), which is nearly impossible to do in true axial spray mode. It is also used to weld thinner material than typical with spray, while using a thicker wire diameter. The main advantages of the Everlast version of the single pulse MIG is that it offers control of the heat and arc cone while maintaining good wet in and travel speeds by pulsing voltage between two different values. Due to the unique design of the Everlast pulse MIG system, short circuit pulse is feasible with steel and stainless alloys and can be used successfully to weld materials as thin as .030" in thickness when properly adjusted. When coupled with either a push-pull gun, or a spool gun, the pulse feature is an excellent tool for use in the production welding or repair of Aluminum alloys.
 - 8) **Pulse TIG Mode.** The pulse TIG feature can be employed to control heat, wicking of the puddle and reduce the arc cone diameter, improving the directability of the arc. The Pulse TIG mode allows the setting of Pulse Amps, Pulse Frequency, and Pulse Time-On. Each features serves to change and shape the welding arc and puddle to control heat, wet-in and penetration.
 - 9) **Pre and Post Flow Control.** The adjustable Pre and Post flow control features are designed to improve weld quality at the beginning and end of the weld where porosity from oxidation can be a problem. This is accomplished by providing adjustable time controls for both pre flow and post flow of shielding gas. This control is active for both MIG and TIG.
 - 10) **Slow Run-in of Wire.** This feature improves arc striking quality in MIG modes by helping prevent arc stuttering (machine gunning) and push-off during arc initiation by slowing the wire speed until the arc is established. **Note: This feature does prevent the user from taking accurate measurements of wire feed speed manually as the wire will feed slower until the arc is struck and maintained.** This is not an adjustable feature and cannot be deactivated.
 - 11) **Spool Gun Modes.** This welder is well equipped to handle the aluminum welding needs of most customers by being both spool gun and push-pull gun ready. The unit can handle several different Everlast spool gun models, but the most capable is the 300 amp, Parker® DSP 360A spool gun. Also the user may want to consider the Everlast SM200N-MTS gun which is a 200+ Amp gun with a 24 series barrel. A spool gun is an economical choice for light to heavy applications requiring a fast deposition rate of aluminum on materials 3/16" or greater in thickness. A spool gun is limited to 4" rolls (usually holding 1 lb of aluminum and 2 lbs of other filler metals) so numerous spools may be needed on larger projects.
- Basic Design and Construction.** This multi-process welder features an intuitive control panel and couples it with digitally controlled IGBT inverter design that produces a stable arc while conserving energy. Everlast utilizes quality components from US, European, and Asian based companies to ensure reliability and parts commonality. Major control components are of a plug-and-play design which allows rapid diagnosis and repair of the welder. Welding parameters can be infinitely and continuously adjusted throughout the range, offering instant welding response for maximum control.
- Installation.** The basic construction of the PowerMTS 251Si is rugged and durable. It is considered ideal for circumstances where portability is of concern. Critical components are protected by coatings to make the welder environmentally resistant and has a water ingress rating of IP21S, (the standard in the welding industry to protect from vertically dripping water). How-

ever, some common-sense care should be exercised to make sure that the welder offers the safest and best performance. Please note the following items regarding safe and proper operations to ensure best service and results while welding:

- 1) Do not use the welder in damp or wet areas. Perspiration and other forms of water in contact with the body can increase the risk of electrocution.
- 2) Do not use the welder in extremely corrosive environments. To maintain optimum power transfer, check main connections, clamps and cables frequently to ensure that components are not corroded. Excessive dirt, corrosion and oxidation can result in an unstable arc and excessive heat build-up. If the work clamp becomes corroded or damaged, be sure to replace it with a heavy-duty work clamp rated for at least 300 amps. If your work clamp appears to become extremely hot while welding, and all connections are clean and secure, replace the work clamp.
- 3) Store the welder covered with a moisture and fire resistant material.
- 4) If used on a mobile cart, strap or fix the welder to the cart so that accidental overturn is not likely.

Duty Cycle/Overcurrent/Under Voltage/Overvoltage Warnings. Thanks to a dual cooling fan design, the PowerMTS 251Si has a duty cycle rating of 40% at 250 Amps while welding in MIG and TIG mode and a rating of 40% @ 200 Amps while welding in stick mode. The duty cycle rating is the amount of time (expressed as a percentage) out of 10 minutes the unit can weld without a rest. For MIG, the unit is capable of welding 4 minutes out of every 10 minutes at the maximum output of 250 Amps. For the balance of the 10 minute period, the unit should be allowed to rest and cool while running. This rating is based off a 40° C maximum temperature. If the unit's duty cycle has been exceeded, the Stop LED will come on and unit will cease welding output. An error code of "E04" will be displayed if a duty cycle event has occurred. Allow the unit to run and cool for 15 minutes. After 15 minutes of cooling the unit while switched on without welding, cycle the power switch to reset the unit. In the event of an overcurrent, the welding output will cease and the "Stop" LED will come on and an error code of E02 will be displayed. In duty cycle and overcurrent events, the wire may continue to feed without output. Overcurrent events can be caused by too low of supply voltage, running on under-sized extension cords, too large of wire diameter, too high of settings for wire diameter, too high of input volt-

age, or internal or external electrical fault. When an overcurrent has occurred, turn the machine off immediately, then check and remedy the fault before switching the welder back on. Under or over voltages will also trigger the Stop LED. The error code of E01 will be displayed. This is likely a result of a poor power supply, a long extension cable, or from running off of a generator that is malfunctioning.

Note: If a generator is going to be used with this unit, please make sure that it is certified by its manufacturer to be "clean power," which is normally stated as less than 5% THD (Total Harmonic Distortion). For proper operation with a generator, make sure you have at least a minimum 9,000 watts of surge capability and 6500 watts of continuous rated output capability.

CONNECTIONS AND POLARITY

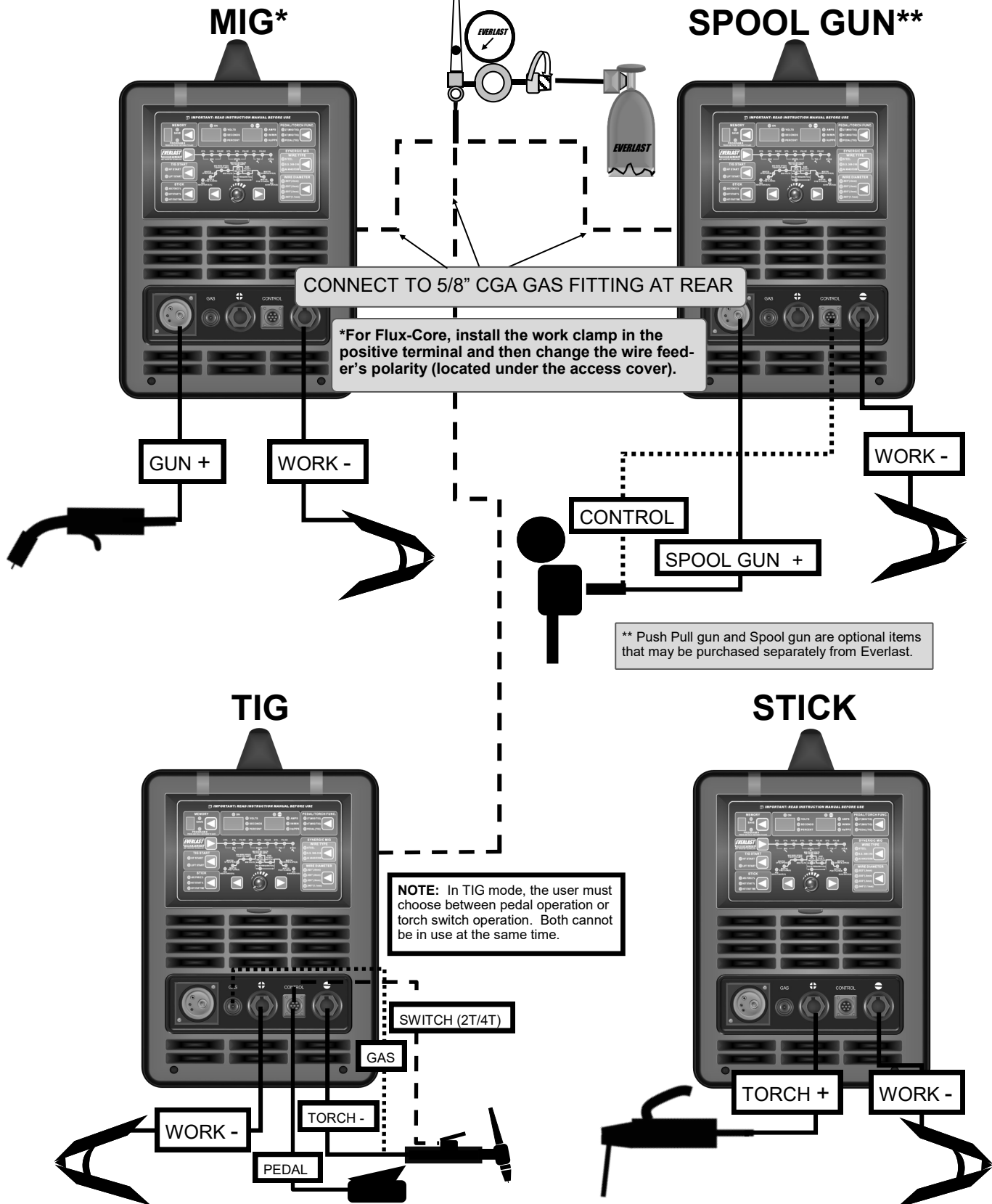

Section 2

Setup Guide and Component Identification

GENERAL POLARITY RECOMMENDATIONS*

Table 1 *Consult the manufacturer of the filler material recommendations concerning polarity .

PROCESS	TORCH POLARITY	WORK POLARITY
MIG (GMAW)	+	-
FLUX CORE (FCAW)	-	+
STICK (SMAW)	+	-
TIG (GTAW)	-	+

Table 2 GAS SELECTION GUIDE

PROCESS	GAS
MIG (GMAW) STEEL	80/20 Ar/CO ₂ or 75/25 Ar/CO ₂ or 100% CO ₂ for short Circuit MIG 80% or higher Argon content or a 90% Ar Steel trimix blend with balance of CO ₂ and O ₂ . (no helium)
MIG (GMAW) STAINLESS	98/2 Ar/O ₂ , 98/2 Ar/CO ₂ , or TriMix/ StainMIX with Helium
MIG DUAL SHIELDED	Follow Manufacturer's recommendation
MIG (GMAW) ALUMINUM	100% Argon
TIG (GTAW) STEEL/STAINLESS	100% Argon

Table 3 MIG (GMAW) CURRENT/WIRE/SINGLE PASS THICKNESS GENERAL SUGGESTIONS

WIRE DIAMETER	WELDING AMPS (A)	PLATE THICKNESS	GAS FLOW RATE
.023" (0.6 mm)	25-110	.040"-.063" (1.0-1.6)	15-20 CFH /7-10 lpm
.030" (0.8 mm))	35-200	.040"-.128" (1.0-3.2)	20-25 CFH/ 10-14 lpm
.035" (0.9 mm)	45-250	.040"-.128" (1.0-3.2)	20-25CFH/ 10-14 lpm
.040" (1.0 mm)	45-250	.050"-.25"+(1.2-6.0+)	25+ CFH/ 14+ lpm
.045" (1.2 mm)	60-250+	.25"+ (6.0+)	25+ CFH/ 14+ lpm
.062" (1.6 mm)	140-250+	.375+ (9.5+)	25+ CFH/ 14+ lpm

IMPORTANT: Use the synergic function of the welder if you are unsure of the best volt and amp settings to use. This feature automatically sets a generally useable volt/amp ratio for you. After this is set, based off of the inputs you have provided for wire diameter and wire type, it is a simple matter of turning the amps up or down until the arc is stable and the sound of the arc is a crisp frying sound. If no workable setting is found, the volts may be adjusted up or down while in synergic mode. Adjusting the volts will reset the volt/amp ratio and create a whole new range of adjustment capability. Changing the shielding gas mix from the standard 75/25 in MIG mode will affect how accurate the volt/amp ratio is. The synergic mode provides much better results in general than a chart can provide. **Please note that in synergic mode, the unit changes to read in Amps, not the actual wire feed speed(IPM) while adjusting.** This is a more accurate method since wire diameter and type is known. Many wire manufacturers provide a range of amps for their wire type in the printed material, or in their online information. Actual suggested amp and volt ranges may differ somewhat from brand to brand. MIG inductance settings will also affect final settings. **Before adjustment of volts and amps begins, set the inductance to approximately 65-75%, then fine tune the inductance only after all fine tuning of volts and amps has been complet-**

Section 2

Setup Guide and Component Identification

TIG (GTAW) OPERATION GUIDE FOR STEEL (ALUMINUM)*

*As a general rule, set amperage using 1 amp for every .001" of metal thickness for aluminum. Less is required for DC.

METAL THICKNESS	WELDING AMPS (A)	TUNGSTEN DIA.	Ar FLOW RATE
1-3 mm/.040"-1/8"	40-80 (60-125)	1-2 mm/.040"-3/32"	8-15 CFH /4-7 lpm
3-6 mm/ 1/8"-1/4"	80-200 (125-200)	2-3 mm/ 3/32"-1/8"	15-25 CFH/ 7-14 lpm
6-10 mm 1/4"-3/8"	150-200 (200-250)	3-6 mm/ 1/8"-1/4"	20+ CFH/10-15 lpm.

STICK (SMAW) OPERATION GUIDE

METAL THICKNESS	ELECTRODE SIZE	WELDING AMPS
< 1 mm/.040"	1.5 mm/ 1/16"	20-40
2 mm/.080"	2 mm/3/32"	40-90
3 mm/ 1/8"	3.2 mm/1/8"	90-110
4-5 mm/ 3/16"	3.2-4 mm/ 1/8"	90-130
6-10 mm/ 1/4"-3/8"	4-5 mm/ 1/8"-5/32"	130-200

TUNGSTEN SELECTION GUIDE FOR AN INVERTER

TYPE	PERCENT	COLOR	PROCESS	RECOMMENDATION
Pure	100% Tungsten	Green	AC	NOT RECOMMENDED! Do not use in an inverter.
Thoriated (slightly radioactive)	2% Thorium	Red	AC/DC	YES. Great for all purpose welding. Most economical.
Ceriated	2% Ceria	Orange	AC/DC	YES. Good for low amp use.
Lanthanated	1.5% Lanthanum	Gold	AC/DC	YES. Best alternative to 2% Thoriated. Tough performer.
Lanthanated	2% Lanthanum	Blue	AC/DC	YES. Slight advantage over 1.5% Lanthanated.
Zirconiated	1% Zirconia	Brown	AC	NOT RECOMMENDED! Do not use in an inverter.

INSTALLING THE WIRE SPOOL

To load the spool of wire:

- Loosen and remove the hand nut on the spool carrier by turning it counter-clockwise.
- Align the locating pin with the hole on the wire spool (if present).
- Slide spool onto the shaft. Make sure wire is unwinding from the bottom of the spool.
- Adjust de-spooling tension by turning tensioner located under the hand nut on the spool carrier.
- Lightly spin the spool. If it free-wheels more than 1/4 turn, tighten hex screw. If it does not free-wheel at all, loosen tensioner until it free wheels 1/4 turn.
- Reinstall the hand nut so the spool is retained securely.
- Locate the end of the wire and clip the bent end of the wire so that it will feed through the wire feed mechanism smoothly. Carefully hold the spool of wire with one hand so the wire will not despool. Proceed to instructions listed below: "To thread wire from the spool properly through the wire feeder into the gun."

NOTE: An adapter/spacer will be needed to use 8" spools. Contact Everlast to purchase one, if you do not have an adapter.

NOTE: Be sure to use special serrated drive rollers while using Flux-Cored wire and dual shielded wires. The serrated rollers are available as an option. Contact Everlast to purchase Flux-core drive rolls. Also, don't forget to change gun polarity to (-).

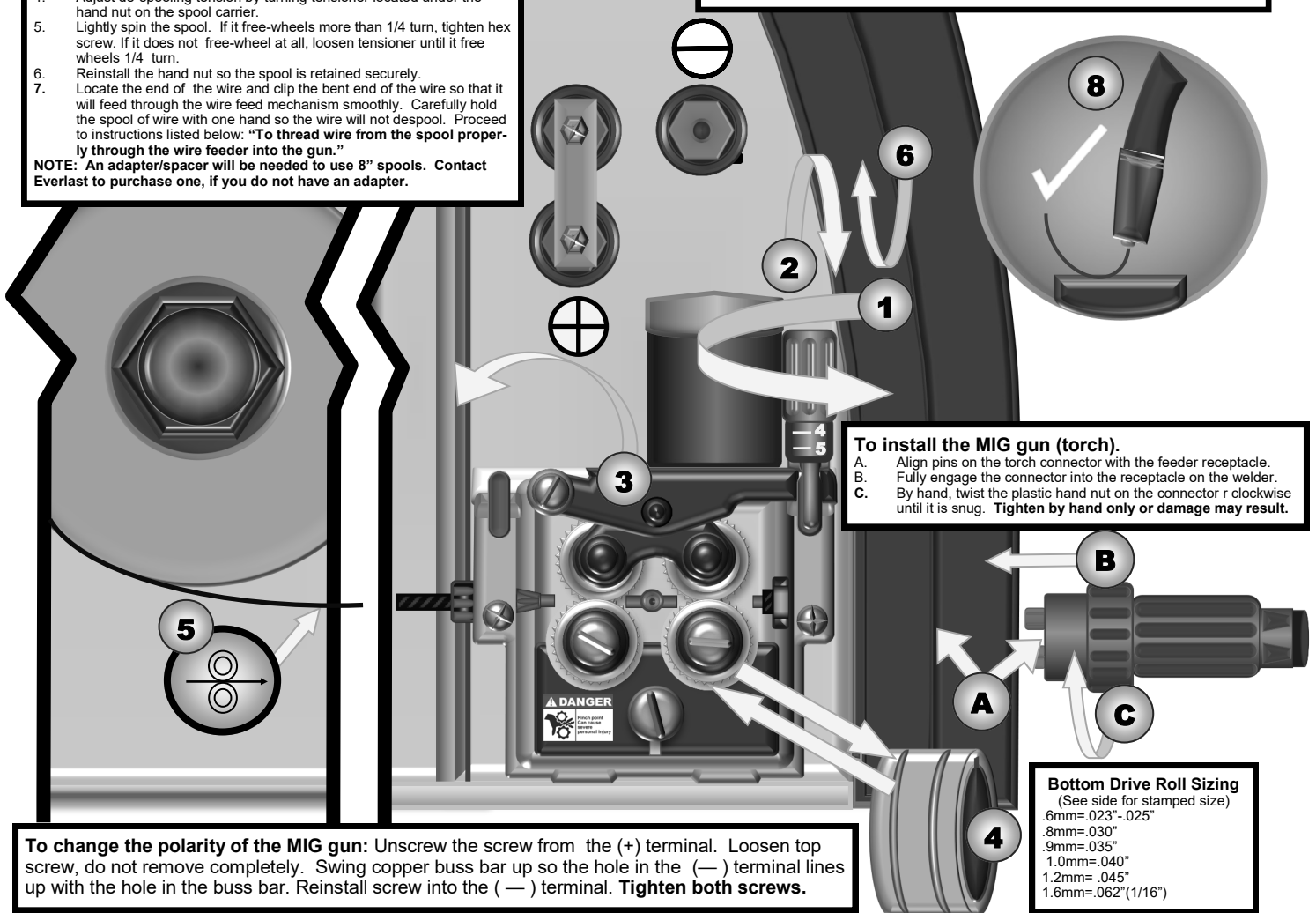

To install the MIG gun (torch).

- Align pins on the torch connector with the feeder receptacle.
- Fully engage the connector into the receptacle on the welder.
- By hand, twist the plastic hand nut on the connector clockwise until it is snug. **Tighten by hand only or damage may result.**

To change the polarity of the MIG gun: Unscrew the screw from the (+) terminal. Loosen top screw, do not remove completely. Swing copper buss bar up so the hole in the (-) terminal lines up with the hole in the buss bar. Reinstall screw into the (-) terminal. **Tighten both screws.**

Bottom Drive Roll Sizing

(See side for stamped size)

.6mm=.023"-.025"
.8mm=.030"
.9mm=.035"
1.0mm=.040"
1.2mm=.045"
1.6mm=.062"(1/16")

To thread the wire from the spool properly through the wire feeder into the gun:

- Install the MIG gun as instructed in "To install the MIG gun (torch)" above. Loosen the top idler roller tensioner, rotating the black tensioner knob counter-clockwise.
- Flip the tensioner down, toward you, releasing the carrier arm that holds the top drive rolls.
- Raise the carrier arm up. Inspect the drive rolls to make sure that each roller's groove size matches the wire diameter. Also make sure correct type of drive rollers are used. i.e. Flux-Core drive rolls use special serrated rolls. (Top driven rollers do not have grooves and are not to be removed).
- Reversal of the lower drive rollers to select the right size drive groove may be necessary. **To reverse the lower drive rolls:** Remove the slotted screws securing each lower drive roll. Pull each retaining spacer. Remove the outer ring of the drive roll and flip the drive roll over. The drive roll is actually made of two pieces. Hold the inner assembly of the drive roll on with one finger (to prevent it from slipping off the shaft), while slipping the outer "rim" of the drive roll off with the other hand. **NOTE: Both inner and outer parts of the assembly have locating keys.** To reinstall: Line up the outer rim of the driver rolls keyway with the locating key. Reassemble and tighten each roller. Make sure both rollers are matched in size. Also make sure the locating keys are in place and have not pushed or slipped out of their grooves during assembly. Lightly coat the inner mating surfaces with light lube if necessary to prevent future seizure. Do not lubricate the surfaces of the drive rolls or wire slipping and erratic feeding may result.
- Follow instructions above: "To Load Spool of Wire."** Make sure the spool of wire is loaded correctly so that the wire unrolls from the bottom of the spool (counter-clockwise). Thread the wire into the coiled guide and over the grooves in lower drive rolls. Thread the wire fully through until it threads into the gun section 4"-6". Lower the upper drive rolls into contact with the lower drive rolls, keeping the wire securely fixed in the grooves of the lower feed rollers. If needed, use a screwdriver with a fine blade or small pick to keep wire from moving out of the grooves until step 6 is completed. Make sure one last time that the correct groove has been selected.
- Raise drive roll tensioner back into place. Tighten it slightly so the wire will feed. Notice markings on tensioner for future reference.
- Remove the contact tip from the torch. (Not Shown).** Hold the torch cable and gun as straight as possible, in direct line with the unit so feeding of the wire through the gun liner is smooth and easy. Press the gun trigger to feed wire until the wire exits the end of the torch. Reinstall the contact tip over the wire and tighten it.
- To prevent bird nesting or slipping of the wire, adjust the tensioner clockwise until the drive rolls will not slip when the wire comes into contact with a hard surface. The wire will curl up on end while feeding under power. If you over-tension the wire, you will increase the chances of bird nesting of the wire (balling up of the wire or curling of the wire around the drive rolls), so it is best to tighten just until wire stops slipping and is able to curl up. Extra tension can deform wire and prematurely wear the drive rolls. Slowing of the feeder may result as well. **Remember not to test on any metal attached to the work clamp to prevent the wire from arcing while performing this test.**

FRONT VIEW/ MAIN PANEL POWER i-MIG 251Si



Front Panel Description and Explanation:

1. **Protective Cover.** The unit features a protective hinged cover. This cover should be lowered whenever welding is actively taking place or when the welder is stored for an extended period of time.
2. **Volts/Seconds/Percent Display and LEDs.** The Volt/Function display works in conjunction with the LEDs directly beside the display. As different parameters are selected, the LED's to the right of the display, that represent the unit of measure that is currently being represented will be lit. The display represents Volts, seconds, and percent. After adjustment is completed to parameters other than Volts, the display will revert to displaying Volts after a few seconds of inactivity.
3. **Amps/Wire Speed/Hz Display and LEDs.** The Amps/Wire Speed/Hz display works in the same way as the Volts/Seconds/Hz Display and LEDs discussed in item 2 above. This display expresses value of the Amps, Wire Feed Speed or Hz (PPS). As one of the Select buttons (#13) are pressed, it cycles through each LED function while the display shows the corresponding selected unit of measure for each function that the digital display is assigned to represent. **NOTE: Depending upon which process is selected, not all functions will be referenced during setup.** After selection/adjustment of the other display related functions is completed or if no adjustment is made after a few seconds, the display will default to the wire feed speed setting, displaying selected wire feed speed in Inches Per Minute (IPM), until welding starts. When welding begins, actual amps output will be displayed dynamically. In the synergic modes, the wire feed speed no longer displays IPM, but displays in Amps. Amps is always represented as the default in synergic mode, as the LED is the same one used to represent IPM in standard and pulse modes. In stick mode, only Amps will be displayed.
4. **LED ON Indicator.** The On indicator should be lit anytime the machine is turned on and the unit is receiving power. If the unit is switched on but no ON light appears and the fans do not start, check for a tripped breaker and check for incoming power at the receptacle. You may notice that the ON indicator along with the displays and fan, may remain powered up to 10 seconds after the unit is switched off as the capacitors discharge. This is part of normal operation and not a defect.
5. **LED Stop Indicator.** This indicator will light up anytime a machine fault or an electrical issue is detected. When this lights up, machine output will cease and an error code will be generated in the display. Wire feeding may continue if the Stop indicator is on, but welding output will cease. If an error code is generated, look up the error code in the troubleshooting section of the manual. Most error codes will require a power down and power up cycle of the unit to clear the codes and restore the operation of the unit.
6. **Synergic Function.** The Synergic function is used to simplify setup and improve results while welding. While similar to auto-setting features in other brands, it is different and more advanced as it takes into account wire diameter and wire type and allows fine tuning without a "one-size fits-all" approach that would prevent you from customizing the arc to your requirements. The synergic mode presets a ratio of wire feed speed to voltage that is useful for operation with the operator selected type of wire and wire diameter. It does not set a particular target voltage or wire speed however since it does not take into account material thickness. The machine sets a minimum default voltage and wire feed speed with a different programmed ratio for each combination of settings. This ratio voltage to wire feed speed is coupled, or rather "locked" together, so that the wire speed feed adjustment knob alone can control both voltage and wire speed feed simultaneously. Even though the machine is in the Synergic mode and the wire feed control is designed to control both voltage and wire speed together, the voltage can be fine-tuned at any time by simply using the voltage adjustment knob to change the voltage. This will establish a new ratio of volts to amps. Once the voltage has been fine tuned to suit the user's preferences, this will reprogram the machine to remember this newly established ratio of volts to amps. The user will then once again be able to use the wire speed to control both the wire speed and voltage together through the wire speed adjustment knob. If further fine tuning is needed, the voltage can be adjusted individually at anytime without affecting the wire speed. This new ratio will be remembered as long as the unit is in the synergic mode. Once the unit has exited the synergic mode or the unit is powered down, the newly established ratio will be cleared from memory. While in synergic mode,

you will notice while cycling between different wire types and wire thicknesses, the basic volt and wire feed settings do not appear to change. This is normal. Keep in mind that the unit defaults to the minimum setting for each synergic setting and only the ratio changes. **The wire speed setting does not change because instead of reading in Inches Per Minute, the machine is programmed to recalibrate itself to read in Amps while in the synergic mode.** Amps are directly linked and controlled by wire feed speed in MIG welding. Due to Ampacity, different wire diameters can deliver a different amount of amps at the same given wire feed speed. So, this is why the unit is calibrated to read in Amps while in the synergic mode. It should be noted that while actively welding, this unit reads actual output amps regardless of standard or synergic modes. **To operate, simply select the type and size of wire being used once a synergic mode is selected.** Selectable options for wire type include: Steel, Aluminum, and Stainless. Wire sizes for the synergic function include, .023", .030", .035", and .045" wire diameters. Some exact wire sizes may vary from what is listed. **Note: With the exception of .062" and larger wires, select the next wire size down if the wire size is not listed on the panel face and the synergic function is desired.** If .062" or similar sized wire is used, select the standard mode and avoid using the synergic feature. The synergic mode is not calibrated for Flux-Core or dual shielded wires, or every possible formulation of filler wire, but does offer a good starting point for most wires. Remember, the synergic mode is designed to assist in setting up the machine and simplifies operation. It will not always offer every user the best setting in all situations. Use it as a tool, and keep in mind that experience is the ultimate resource for proper machine setup. **Special Note concerning Synergic operation with the spool gun: Make sure if you purchase a spool gun for operation with this unit, that a MTS version of the spool gun is purchased. This will offer you excellent control of both Amps and Volts through the speed control knob located on the spool gun. This is something particularly useful and will allow you better control than any other brand or type of spool gun on the current market by reducing your need to visit the panel to make corrections to voltage while welding. You will not be able to adjust amps/wire speed on**

the panel in synergic mode since wire speed/amp control is routed through the gun, but will still be able to fine tune voltage on the panel if needed. Otherwise, the synergic spool gun mode operates essentially the same as the Synergic MIG mode.

7. **Pedal/2T/4T selector.** Press the button to select one of the torch switch or pedal function modes. Select 2T for simple press-and-hold operation of the torch switch. For 2T operation with the torch switch: 1) Press and hold the switch to start the arc and weld. Release the switch to cease welding. Select 4T for advanced use of the sequencer controls on the panel such as pre-flow, post-flow, up slope and down slope. To operate in 4T mode with the torch switch/remote: 1) Press and release the switch to start arc. 2) The current will begin to upslope to reach normal welding current. 3) Press and hold switch to begin downslope. 4) Release switch to terminate the arc. In 4T mode, if the puddle becomes too hot, it can be cooled by lightly tapping the switch to begin downslope and tapping again to restart upslope before end current is reached. Setting a long downslope helps improve heat control in 4T as the torch switch is cycled between downslope and upslope before the arc is terminated. **IMPORTANT: To use the foot pedal mode select pedal mode and adjust TIG amps to the maximum desired setting.** The pedal will then control the amperage throughout the entire range of amps up to the maximum selected amperage, based off the pedal position.] The foot pedal is for TIG use only. The 2T 4T modes can be with TIG mode or MIG mode.
8. **Mode (Process) Selector.** Select the desired process by toggling the arrow button. Each press of the button will advance and highlight the next process to the right. Select between the following processes: Standard MIG mode, Synergic MIG mode, Pulse MIG mode, Standard Spool Gun mode, Synergic Spool Gun mode, Pulse Spool-Gun mode, Standard TIG mode, Pulse TIG mode and stick mode. **In standard MIG or Standard Spool gun modes, volts and amps are controlled completely independent of each other.** When Synergic MIG or Synergic Spool gun mode is selected, the Synergic mode LED will light above the synergic section to remind you that the operation is synergic instead of manual. In stick mode, almost all electrodes can be used except rods with a high percentage of cellulose in the flux. If using with cellulosic rods, such as E 6010, less than satisfactory performance may be experi-

enced. Consider using other welders capable of supporting E 6010 use if this rod is frequently used. However, most all other rods weld easily in stick mode.

9. **Program Selector and Save Function.** A combined total of 9 different programs may be saved, whether it is in MIG, TIG, Stick or Spool Gun operation. Nine programs is sufficient to allow the most frequently used settings to be stored and instantly recalled by using the green selector button to toggle to the stored program number. Keep in mind that the unit is not designed to save 9 programs in each process, but only a total of nine programs. To save a program, toggle with the green selector button to the desired number where you wish to save the program. During toggling, the Program number LED will light up. Make sure this is an unsaved program number or one that you are willing to have erased as the programming does not block you from saving over an old program. Make sure all desired settings are correct before you save. Then press and hold the green selector button for around 3 seconds. Release the selector button when the "SAVED" light illuminates. The "SAVED" light stay lit briefly to confirm the program has been properly saved. After the program has been saved and selection activity ceases, the "PROGRAM NUMBER" LED will go out. Be sure to write down which program you have saved and the basic settings you wish to preserve in case you accidentally resave over an old program.
10. **TIG Start Type Selector.** The unit features the capability to select from two start types when welding in TIG mode. The default mode is High Frequency Start (HF Start). This allows the arc to be started while holding the tungsten just above the metal, without having to make contact. This results in smoother, contaminant free arc starts. A HF pulse is generated which will bridge the gap between the Tungsten and the work piece. This establishes the arc. This is a unique feature on the PowerMTS, but is an expected feature on any true TIG welder. The second type of start is the Lift Start. This requires the tungsten to be touched to the metal and lifted up to start the arc. This is not as clean of a start as HF and some tungsten and/or work piece contamination may occur from time to time. This is still a smoother start than a typical scratch type start but not as smooth or easy as

an HF start. This is the same type start found on many MIG/TIG/Stick welders in it's class. It is more primitive, but does a good job when HF start is not required or is restricted in HF sensitive environments such as hospitals, near electronic equipment.

11. **Stick Arc Control Selector.** In stick mode, there are 3 additional functions besides Amp adjustment that the user has control over. The first is the arc force percent. The arc force percent will be represented in the left display and is adjusted from 0-100%. This gauges the amount of amp reaction, or boost, when the arc voltage begins to drop below satisfactory levels (< 20V)while welding. This helps to prevent the arc from going out or the rod from sticking in the puddle when the rod is held close to the puddle while welding. The goal of arc force is to help maintain overall wattage. The setting range of arc force control is the % of available amperage over and above the standard welding amperage that the programming will boost the amperage to maintain the arc. . It can also be used to help increase penetration by "pushing into the puddle" when more heat is needed. This feature can also be referred to as "Arc Dig" as it allows the user to tightly control the arc without losing needed fluidity of the puddle. As a good starting point, consider setting arc force for around 30-35%. If welding with a cellulosic rod, such as E6011, more arc force will be needed. Begin at 50% and work up to 70% to maintain best arc performance. If E6010 is required, though not recommended due to possible arc stability questions, settings of 70% or greater may be required. The second adjustment is Hot Start %. This is similar to arc force control as it boosts Amperage, but different in the fact it is not arc length dependent. The Hot Start boosts the Amps only at the start of the arc, to help bring the weld and rod up to temperature quickly, thereby reducing the effects of a colder start which usually results in porosity and poor fusion under the arc start area. It also helps to reduce failed arc start attempts. The Hot Start % setting is often referred to Hot Start Intensity, as it adjusts how aggressive the Hot Start will be. A good preliminary setting is anywhere between 30-50%. The third adjustment is Hot Start Time. This adjustment simply is used to define how long the Hot Start function stays engaged once the arc strike occurs. For a starting point, adjust Hot Start Time to .2 to .3 seconds, increasing or decreasing from there, as needed. **HINT: Use more Hot Start**

Time and Intensity for thicker metals and thicker rods.

12. **Sequencer.** The sequencer controls the arc cycle and other related parameters to the selected process's function. These are controlled by the selector buttons in # 13. The sequencer controls items such as pre flow, post flow, TIG/MIG Upslope, TIG/MIG Down Slope, MIG Volts, MIG Pulse Volts, MIG Inductance, MIG Burn back, MIG Pulse Parameters, TIG Amps, TIG Pulse Amps, and other TIG Pulse parameters. See the "Additional features located within the sequencer" section, immediately following item #19 for further expanded discussion of the features found within the sequencer chart.
13. **Selector Buttons.** The selector buttons are used to highlight each function found in the sequencer. Pressing the left button will move the highlighted LED to the next applicable function in the sequencer chart. Pressing the right button will move the highlighted LED to the next applicable function in the sequencer chart. Depending upon the process selected, some LED's will be skipped over as the button is pressed. Do not let that confuse you as some features are not related to the process you have chosen. As each function is selected, the value may be represented in seconds, volts, amps, percent or in Hertz. As the sequencer is cycled left or right, the display to be read to determine the value of the highlighted sequencer feature and the LED representing the unit of measurement may change.
14. **Adjustment Control.** Any adjustable value, including volts and amps is controlled through this single knob. To adjust, highlight the desired LED related to the function you wish to adjust by using the Selector buttons (#13) for MIG and TIG sequencer, or the Selector button for related Stick functions (#11). Then turn clockwise to increase the value of the feature, or counter clockwise to decrease the value of the feature. While turning, you will feel fine "clicks" or stops in the movement of the knob. This is normal and each click will increase or decrease the value by the smallest unit of measure the function is programmed to display. This may prove slow or tedious when large amounts of change in value are required. To adjust in greater increments (10x), push the knob in slightly, until greater resistance is felt and turn the knob at the same time. This will expedite the adjustment process, when large changes are required.
15. **Euro Quick Connect for MIG Gun.** This style of connection makes the Power i-MIG compatible with many after market MIG torches/guns. Connect the MIG torch by aligning pins on the gun cable with the receptacle and pushing in. Twist the collar on the cable connector to lock in place. Do not use pliers or other tools to tighten. Hand tighten only. This type of gun connection is typically superior to many others because it is self contained, does not require tools to connect and does not have a separate control connector that also needs to be plugged. This connector has a reliable and proven track record with many companies throughout the world. **Note: When using the spool gun with this welder, this port also becomes the attachment point for the spool gun, so the main gun will need to be removed to connect the Spool Gun.**
16. **Gas Connector.** This welder is equipped with a separate connection point for TIG. By doing so, this allows you to have automatic control of gas flow and a direct connection point for the gas line on the front of the panel. This eliminates clumsy connections that may be required otherwise, and eliminates the need to use a more bulky gas valve torch that only provides manual control of gas flow. Having a gas solenoid valve and panel connection like this can reduce gas wasting and accidental and costly outflow of shielding gas when not actively TIG welding. This connection is currently only provided for TIG welding and is not related to any MIG or Spool Gun operation.
17. **Positive Polarity Connector (+).** This front mounted connector terminal is a standard 35 series DINSE style connector. It provides a positive polarity output. When using stick mode, connect the cable from the electrode holder to this terminal for most electrodes and applications. When using Flux-core or dual shield, connect the work clamp to this port, unless the wire manufacturer specifically states an electrode positive polarity (also referred to as Reverse Polarity). When using TIG mode, connect the work clamp to this connector.
18. **Control.** This seven pin plug is used to control wire speed when the spool gun or push-pull

Release the button and it will automatically spring back and return to adjusting in smaller increments.

gun when it is connected.

- 19. Negative Polarity Connector (-).** This front mounted connector terminal is a standard 35 series DINSE style connector. It provides negative polarity output. When using stick mode, connect the cable from the work clamp to this terminal for most applications. When using Flux-core or dual shield, change polarity inside the machine by changing the buss-bar position, unless the wire manufacturer states to use electrode positive. Do not use this connection for most Flux-core and Dual shield wires that require Electrode negative polarity (Straight Polarity) Connect the work clamp to this side while in MIG/Stick mode. Connect the TIG torch to this side while in TIG mode. **HINT: Don't forget to change the work clamp when changing to TIG or from TIG to the other processes. Failing to do so will result in erratic operation of the selected process. This is a common issue that prompts many to call technical support.**

Additional features located within the Sequencer.

- 1. MIG Inductance.** *(Located on the far left side of the Sequencer Graph.)* Varies the current-rise time while welding after the arc shorts to the puddle during the short-circuit transfer process. This affects the actual physical point where the current has risen sufficiently to melt back the wire, subsequently pinching off and depositing in the puddle. The physical point at which the wire has burned back is considered the "pinch point" of the arc. This is where the wire will melt back to before transferring the wire back to the puddle to once again short out. To put it in more practical terms, the user will see that the wire is sticking out longer or shorter from the MIG torch before it burns away, depending upon the exact setting. This controls spatter, penetration and bead profile. When the arc force knob is rotated from one extreme to the other, the operator will observe that the arc is more stiff at one end or more fluid at the other end. Bead profile changes will occur as well. A stiffer arc will produce a deeper but more narrow profile. A fluid arc will produce a wider, shallower weld, usually with an improved bead appearance and less spatter. Arc force control is also known as inductance control, slope or wave form control (MIG). By changing the level of inductance, the user can fine tune the arc performance so the welder responds in a manner that the user is accustomed
- to with other brands of machines. The arc sound will also change as the arc force is adjusted, going from a relatively high pitched whine to a frying sizzle. All MIGs, regardless of brand, without an adjustable arc force, do have some fixed level of inductance, though not all are set at the same level. A user can either adjust the inductance to have a familiar feel, or to improve arc behavior whenever welding position or condition change. This control is primarily useful for short circuit welding and has limited value in Axial Spray. While using many types of flux core or dual shield, manufacturers will often specify a setting of "0", though "0" is a relative value, and inductance cannot be completely eliminated. In MIG, excessive or too little amounts of inductance can create a violent arc or an unstable one, so be careful about selecting too much or too little. A good starting point is around 60 or 70%. Make gradual, changes to fine tune the inductance. Giant swings will make other parameters harder to dial in properly as the inductance can greatly affect the feel of welding arc in both modes. Set the amount of inductance to the approximate level desired before tuning other parameters (whether you are in standard or pulse modes). Do not attempt to further alter inductance until all other parameters are fine tuned as much as possible. After Volt and Amp adjustments are tuned to the best setting you can achieve, then fine tune the inductance level as the final stage of MIG adjustment.
- 2. Burn Back Timer Control.** *(Located on the far right side of the Sequencer Graph.)* The burn back timer controls the amount of time that the arc stays engaged *after* the trigger is released and the wire feeding stops. This is to help reduce wire stick out and reduce the need to trim the wire before starting another weld. This also serves to prevent the wire from sticking in the weld puddle once the arc is stopped. For best results this should be used with the Post flow feature so that the wire does not become oxidized during the burn back phase. If too much burn back is used, the wire may burn back up into the tip. Increase burn back by only a couple tenths of a second at a time to prevent over adjusting the burn back and destroying the contact tip. Generally burn back control will produce consistent results and increase production. Different wire diameters and feed rates will change the burn back time requirement. Keep in mind burn back control is another tool designed to help increase quality and ease of welding. Time can be set at

- “0.0” without severely affecting weld quality.
3. **Pre-Flow and Post-Flow of Shielding Gas.** Both Pre flow and Post flow are functional in the MIG and TIG welding processes. However, many MIG welders do not provide Pre and Post flow of shielding gas. This is a reason that many people do not consider MIG for high quality welds, where porosity must be minimized. By providing a Pre-flow and Post-flow of shielding gas in MIG mode, the weld will be much cleaner, with less porosity at both the beginning and the end of the weld. Additionally the wire ball will not be oxidized, reducing the need to trim the wire before starting. However, if you are trying to conserve MIG gas, the Pre and Post-flow time may be set to “0.0” if the MIG welding is not of a critical nature. For best results, set Pre-flow time for about .5 seconds and Post-flow time for at least 2 seconds. Add more time as amps are increased if needed. While In TIG mode, Pre-flow is required to prevent balling and oxidation of the tungsten when the arc is struck. It also helps to flood the area to be welded with shielding gas before the arc is initiated. Post-Flow in TIG mode is also essential to providing shielding of the tungsten and weld as they cool together to prevent oxidation of the tungsten and porosity in the coalescing weld. As a starting point, set at least .2 seconds Pre-Flow time. For Post-Flow set approximately .5 seconds of Post-Flow for every 10-12 amps used. **HINT: The arc start of both MIG and TIG will be delayed until the Pre-Flow time has been satisfied. This is not considered to be a fault. The arc simply cannot be started until the defined amount of Pre-flow time has expired. If arc start feels excessively delayed, check your Pre-Flow settings.**
 4. **MIG and TIG Upslope/Downslope.** This control is active in both MIG and TIG modes. In the TIG mode, the function is only necessary if you are operating with the Torch switch instead of the foot pedal. If operating in either TIG mode with a foot pedal, set both Upslope and Downslope to “0.0” if the programming allows. (Some program versions may allow adjustment of slopes with the foot pedal while others may block this feature with the foot pedal.) In TIG mode, Upslope adjusts the amount of time it takes for the amps to be raised from the minimum arc start amps to the maximum selected amps. Start amps are factory preset and this point is not adjustable. Downslope is similar in TIG mode except it is the amount of time it takes for the unit to decrease Amps from the maximum set amps to the minimum arc termination amps. End amps where the arc is terminated is factory pre-set and nonadjustable. For MIG operation, the up and down slope functions are similar in concept, except the unit is actually upsloping and downsloping voltage, instead of amps. MIG Upslope works in conjunction with the slow run in to help soften (or increase) the run-in effect. For MIG Downslope, the goal is to help aid in filling the weld crater. This is particularly useful in the 4T setting of the final motion of the trigger, to gradually cool the weld and fill the crater just before the arc terminates. The amount of time allowed for slope (Up or down) is different than TIG because of the short run-in time that is programmed into the machine and the limited time needed for crater filling. If the standard run-in is satisfactory or standard operation is desired, either of these settings may be kept at “0.0”
 5. **MIG Wire Speed, TIG and Stick Amps.** Amperage, simply described, controls penetration during welding. Amp adjustment is allowed in all modes. However in the standard MIG and spool gun modes, Amps are controlled by adjusting the wire feed speed rate (IPM). The faster the wire feeds into the puddle, amperage will climb proportionately according to the wire size. The larger the diameter of the wire, the slower the wire needs to feed to obtain the same amperage. In the same manner, more wire speed is needed with a smaller diameter wire to obtain an equal amp value of a larger diameter wire. You will notice as you set up the synergic mode that the unit displays selected amperage instead of wire feed speed (IPM). This is because the synergic mode, requires you to enter the wire diameter and wire type. This allows the welder’s programming to accurately pre-figure amps being set based off these two parameters. Amps are a more accurate figure to use in this situation. Regardless of what process is selected, the function of the display changes to reflect the realtime amp output while welding. If adjustments are completed, the unit will default to back to Amps within a few seconds. If used in the Pulse TIG mode, the unit will default to “TIG Pulse Amps.”
 6. **MIG Volts.** Voltage dictates the height and width of the bead while MIG welding. If Voltage are set too low, the weld will appear ropey and cold and the wire may even stub into the puddle. If the voltage is set too high, undercut may develop at

the toes of the weld, or burn through may occur. In Pulse MIG mode, the MIG Volts will not be selectable and will default to MIG Pulse Volts when the Voltage is selected. Voltage is not adjustable in TIG or Stick mode. In these processes, Voltage is controlled by arc length. Heat generated by voltage in stick mode can be managed through consistent feeding of the rod into the puddle to control the arc length.

7. **PULSE MIG and TIG Features.** *See individual sections on pulse found later in this manual.*

SIDE VIEW POWER MTS 251Si



Side Description and Explanation:

1. **Wire Spool Carrier Assembly.** Make note of the correct assembly order if disassembled. *The order in which they are assembled is important to be able to provide enough resistance to prevent de-spooling of the wire.* When inserting the spool, make sure the small tab or dowel on the inside of the spool holder is correctly located in one of the recesses made into the spool. After installing the spool of wire, tighten the hex head tensioning nut located under the spool retaining nut so that the wire will not continue to roll more than a 1/8th to 1/4th of a turn after the wire has stopped feeding. Do not tighten the tensioning nut to the point that the drive roller slips or the feeder motor strains while feeding the wire. The spool carrier assembly can accommodate rolls of wire 12" in diameter. The carrier can also support the use 8" rolls of wire with an optional adapter. If you do not have an adapter, contact Everlast to purchase one. **NOTE:** 4" rolls of wire are not supported.
2. **Polarity Buss Bar.** Note the "+" and "-" symbols located on the inside of the unit next to the buss bar terminals. The unit is shipped with the torch polarity connected to the positive terminal. Positive polarity is designed to weld with solid wires. To weld with most Flux-core or dual shielded wires, the polarity must be changed to negative. To change the polarity to negative, simply loosen the top screw and remove the other screw located on the positive polarity terminal. By pivoting the buss bar on the screw that has been loosened, the buss bar can be easily swung into position over the negative terminal. Reinstall the screws, lining up the holes in the buss bar with the negative terminal threads. Install and tighten both buss bar screws. Always remember to alter your work clamp to reflect the polarity change if using flux core. If the buss bar is connected to negative, then the work clamp should be in the "+" positive output terminal. **Standard polarity for MIG is "+" (DCEP) with the work clamp in the negative.**
3. **Wire Feed Assembly.** Note the numbers on the side of the tensioner. These numbers are a reference point to help properly tension the wire so that the drive roller will not slip. Do not over-tension the wire because it can create a condition known as birds nesting, where the wire will tangle up around the feeder and will not slip if the wire burns back into tip, sticks fast in the

weld puddle or other resistance is met. This will continue wrap the wire around the drive mechanism or will jam wire inside the gun liner until the trigger is released. Considerable effort is usually needed to clear out a bird's nest condition. Too little tension will result in wire slippage and cause rapid wear on the drive components. Do a feed test before beginning a weld. Occasional cleaning of the feeder mechanism is necessary to prevent wear and damage to the feeder and to the MIG gun liner. Regularly monitor any metal flaking and dirt build up that may occur in the wire feed area. Clean it away gently with compressed air. Also to improve MIG gun liner service life, blow out the gun liner with compressed air after running a complete full size roll through. Do not use harsh cleaners or solvents to maintain the cleanliness of the feeder mechanism. Felt wire lubricators may be bought and used to keep feeding cleanly while using steel or stainless wire. **Your unit has been supplied with additional drive roll sizes. Do not forget to change the contact tip size when changing to another wire diameter.** Depending upon the diameter of the wire used, the MIG gun liner may need to be changed to work properly. However, the 36 series gun should be able to feed most MIG wire diameters without requiring a liner change. If trouble is experienced with feeding, purchase a liner specifically sized for your diameter wire.

REAR VIEW/BACK PANEL POWERMTS 251Si

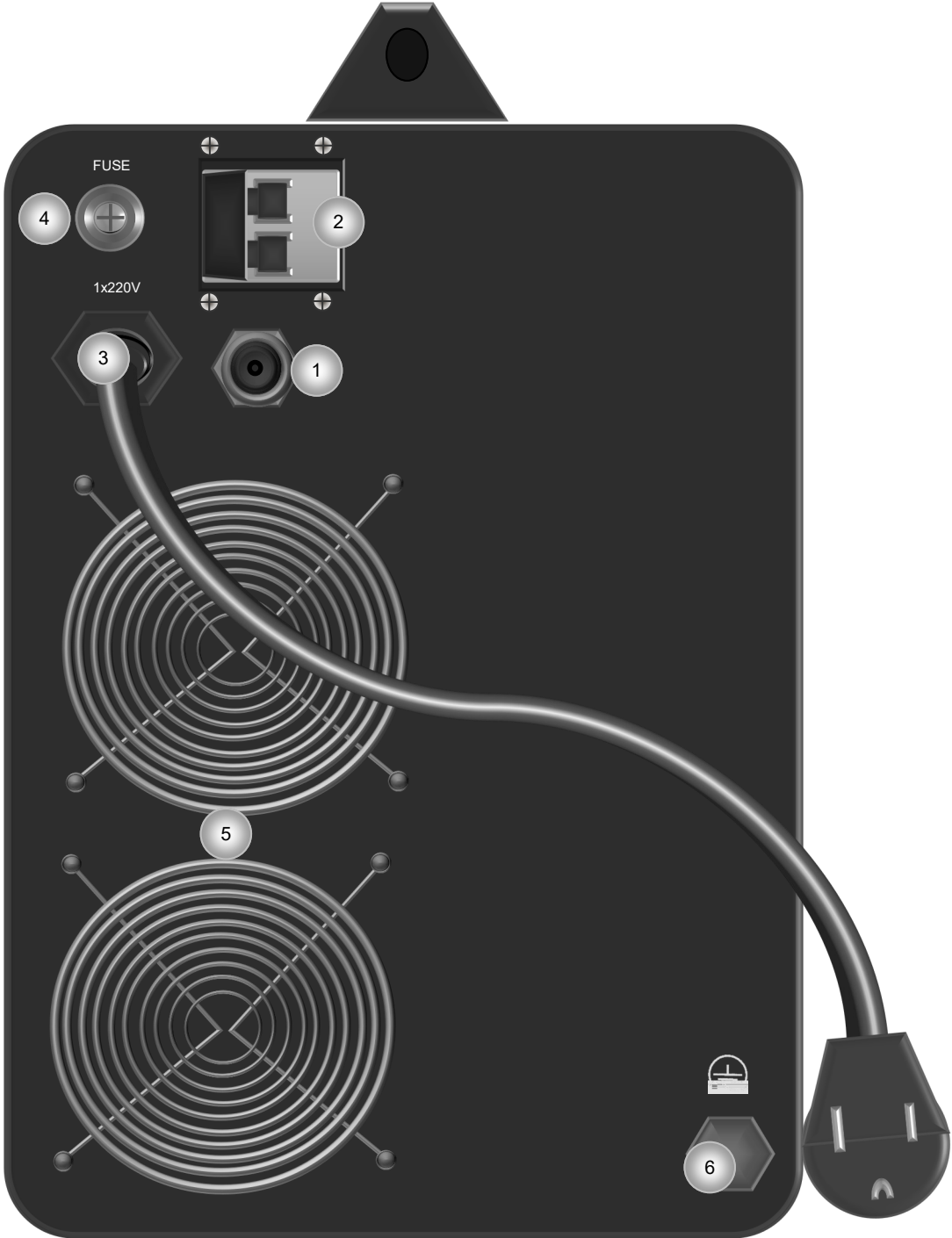

Rear Panel Description and Explanation:

1. **Gas Supply.** Connect the Gas regulator hose to this point via the brass barb fitting. (Regulator is customer supplied and not provided as standard equipment at time of publication.) The hose barb connection must be tight to prevent gas leakage. Install extra clamp if needed to prevent gas from escaping.
2. **Power Switch.** Turns unit on or off. This is a 2 pole single phase 240V breaker-type switch. If it is switched to the left, this means the unit is switched off. If it is switched to the right, and the unit is plugged into a good power supply, the unit should power up. **Note: When switched off, the unit will continue to run and appear to be switched on for up to 10 seconds as the capacitors discharge. This is normal.** However, If the unit will not switch off for some reason, the switch may be damaged. Turn off the unit at the main circuit breaker, and contact Everlast technical. Do not continue to use.
3. **Power Input Cable and NEMA 6-50P Plug.** The Power i-MIG 275S requires 220/240 V single phase 50/60 Hz power input. If necessary this unit will operate on 208V input as it is within the 10% voltage allowance. If actual voltage is below 205 volts, the unit may not function correctly. If used on a generator, the generator must be labeled as "clean power" and provide less than 5% THD. Consult your generator manufacturer for information regarding the clean power rating on specific units. Everlast does not provide a list of approved generators. Manufacturers rate their units as clean power independently according to industry standards. The plug is the NEMA 6-50P. This is the standard plug for welders operating on 240V in the US and Canada. Other countries will have different configurations.
4. **Fuse. Slow blow, 10A (Older models may vary, consult the fuse itself for confirmation.)** This controls the main power to the panel and fans. If the unit suddenly stops, and no power to the panel is observed and the fans are not running, first check the main circuit breaker at the power panel and the power switch position on the back. Reset if necessary. If power isn't restored check this fuse. It's a standard automotive type 10A slow blow type available at many auto parts and electronic supply stores. Fuses can blow from overloading, circuit defect or simply from operation over time. If the wire feeder quits feeding, and all other signs are correct, it may be another fuse issue.
5. **Fans.** The unit is equipped with a dual fan system, which offers quieter and more efficient cooling. It must operate free of obstruction to preserve the high duty cycle which it offers. Keep all objects or restrictions at least 12" from all sides of if the unit for proper cooling. If possible allow 18". Allow the unit to rest on the rubber pads/feet mounted on the welder. Do not have the bottom of the unit supported directly on the metal pan so air can circulate around the bottom as well. Do not run in an enclosed space such as a cabinet or work box. Do not grind or weld where sparks are directed toward the rear of the unit or metallic particles will build up on the fan blades and also on interior components. If metal builds up on the fan blades, it can cause them to vibrate and ultimately fail.
6. **Ground Bolt.** The unit is equipped with an additional grounding point for applications requiring a bonded ground. Under most conditions, the use of the ground is not required. Consult a local licensed electrician for installation and use of this connection.

BASIC MIG OPERATION

General Setup of Amps and Volts.

When welding with the Power i-MIG, the two main functions that require adjustment are Voltage and Wire feed speed. The function of voltage in MIG welding is to control the overall width and to a great extent, the height of the weld bead. In other words, voltage controls the bead profile. The wire feed speed directly controls the amps, and in turn amps control penetration. When setting the welder up you will notice that the wire speed is displayed in Inches Per Minute. However, while actively welding, the display will change function and display actual amp output. The relationship between wire diameter, wire speed and amps is easily figured with the following approximate industry conversions:

.023": 3.5 x Amps = Inches per minute (IPM)

.025": 3.1 x Amps = Inches per minute (IPM)

.030": 2 x Amps = Inches per minute (IPM)

.035": 1.6 x Amps = Inches per minute (IPM)

.045": 1 x Amps = Inches per Minute (IPM)

To convert wire speed (IPM) into approximate Amps, use the following conversion formula:

.023": $IPM \div 3.5 = \text{Amps}$

.025": $IPM \div 3.1 = \text{Amps}$

.030": $IPM \div 2 = \text{Amps}$

.035": $IPM \div 1.6 = \text{Amps}$

.045": $IPM \div 1 = \text{Amps}$

Keep in mind these are approximate conversions and do fall off in accuracy as amps are increased into the upper current limits for the given wire diameter.

Even though you will find general recommendations about setting the Amps, Volts and even shielding gas through a variety of free downloadable apps and online calculators, every filler metal manufacturer has its own specific parameters for Volt and Amp settings for each wire diameter and class of wire. The ranges of volt and amp parameters generally varies somewhat from brand to brand, so be sure to read the packaging and/or manufacturer literature to determine what range of settings are recommended. The wire diameter also limits the practical maximum thickness of what can be reasonably welded. The issue with following charts, graphs and calculator recommendations is that most people find

them either too hot or too cold. For some people, it may not even close. However, nothing can substitute for watching the arc and listening to the sound of the arc. A crisp, steady sound, frequently referred to as a "Bacon frying sound" should be heard. The actual frying sound can vary somewhat and may have somewhat of a high pitch whine to it somewhere between the sound of a flying bee and a mosquito. If these sounds are present, look at the arc to see if it is steady, and producing low amounts of spatter. If large amounts of spatter are present, the puddle seems fluid (appears wet) and the wire speed is within the targeted range, decrease volts a little at a time to reduce the spatter. If this does not correct the problem, change the torch angle and torch height. Hold the torch more vertical, with less than a 15 degree deviation from vertical and reduce stick-out of wire to 3/8" or less. If this still does not help, reduce the wire speed. Some spatter is normal, though it should be minimal overall.

The wire can also pop and spatter if the voltage is too low for the wire speed and/or wire diameter. This is mostly observed as flying bits of red-hot but un-melted wire, along with popping as the wire inconsistently stubs into the puddle. This is followed by the wire pushing back against your hand pressure while the wire visibly turns white/red hot before burning off. Too low of voltage will also produce a high piled bead with the toes (edges) of the weld not properly wetting in resulting in poor fusion.

Arc Force Control.

The third important variable in setting up the Power i-MIG is the arc force control. This third adjustment can greatly vary the feel of the arc at any given volt and amp setting. It is used to balance the stiffness of the arc against the wetness of the arc. Some professionals refer to the "buttery-ness" of the arc. "Buttery-ness" is arguably somewhat a subjective term. However, it generally refers to how smooth and fluid the arc feels and looks. In fact, the inductance alone can affect how much wire speed or voltage is needed in any given application. It does not typically require altering of the Volts or the Wire Speed settings. However the arc force control can expose poorly selected Volt/Wire Speed parameters by magnifying the effects.

BASIC MIG OPERATION

While Everlast uses the term “arc force”, it is known by many different terms. Often it is referred to as inductance, choke or slope. Simply put, the arc force (Inductance) adjustment controls how long it takes the current to recover and rise to the established welding current to melt the wire after the wire contacts the puddle and the current falls. This process is happening many times a second so it isn't visible to the naked eye. But the overall effect is visible as the wire burn off height is changed and a change in the wetness of the puddle and how easily the molten metal flows in toward the toes of the weld as it melts off. If the unit has sufficient arc force, the edges of the weld will easily wick into the puddle with little or no spatter with little or no manipulation of the torch required. The pitch of the arc will be medium. With too much inductance the puddle may be uncontrollable and the arc will have a throaty, raspy sound. Too little inductance and the puddle will be narrow and possibly have a high ridge in the center. The pitch will be very high and the puddle will seem sluggish and less fluid.

All MIGs have a preset inductance or arc force that is inherent in the machine's design. But few MIGs have the adjustable Arc force. Arc force is part of the personality of a MIG welder. It's one reason that some people prefer the arc of one brand over the other as people develop personal preferences in arc performance. With that in mind, having an adjustable arc force serves several functions:

- 1) The arc force allows the user to dial the machine to a performance level that the user is accustomed to. This helps if multiple users are present and improves the operator's performance with the welder.
- 2) The arc force can help improve control and weldability in out-of-position welds (weld positions other than flat) without having to change other parameters.
- 3) Different shielding gases require different levels of inductance for optimum performance. The arc force improves performance with different gas mixes by being able to adjust the arc to render the best and smoothest possible arc for the shielding gas being used. This is especially helpful when pure CO₂ is used.
- 4) The arc force can improve weldability of thinner metals without having to step down a size in

wire. While ultimately there are limits to what any given wire can weld on the lower end of its range, it does help improve the low amp welding characteristics of the wire diameter.

For the best possible experience welding with the Power i-MIG, adjust arc force after the wire speed and voltage have been tuned. This will keep the user from constantly having to hunt for the best balance of the other two adjustments. Usually once a particular arc force setting is selected that is suitable to the user, it will work well throughout the range of adjustments and will rarely require readjustment once set to the operator's satisfaction. However, this is not to say that readjusting the arc force from time to time is not beneficial. When the operator must weld out-of-position, readjusting the arc force control can help reduce clogging of the nozzle and even make the puddle more controllable.

Avoid the temptation of setting the control at the mid-point or even full left or full right without performing a few test welds first. Few users will find these settings to their liking. Turning the arc force to the minimum setting does not turn the feature off. A good starting point is somewhere between 6 and 8 with mixed gas. This will usually produce a desirable arc with for most people and will produce minimal spatter. Fine tune the adjustment from there increasing in half increments to find the best performance.

Burn Back Control.

After the trigger is released on the welder, it's natural for a small extra amount of wire to coast out of the gun. This small amount of extra wire may stick fast in the weld as the molten puddle begins to cool. This will require the operator to break it loose and spend time trimming the wire. Even if the wire does not stick in the puddle, it will often be left sticking too far out from the contact tip for a proper restart. Trimming is usually required with a pair of MIG pliers or wire cutter before restarting the arc. With burn back control, however, the arc can be kept energized long enough to continue supplying power to the wire long enough to burn the wire back to the desired length after the wire stops feeding. The timer control located under the cover sets the length of time that the arc remains on after the trigger is

BASIC MIG OPERATION

released.

If the burn back control is set too long it can cause the wire to burn back into the tip itself and welding of the wire to the tip. Begin with setting the unit for a little less than a quarter second. If the burn back control is set correctly, it will leave about 1/4"-3/8" wire sticking out beyond the contact tip. If a large ball develops on the end of the wire, reduce the burn back time so that it creates a balance between ball size and stick-out. The short amount of post flow that is built into the programming of the Power i-MIG helps shield while the wire is burning back. This helps control balling and prevents oxidation during burn back. This is a unique feature that is not found in many welders with burn back control. Burn-back control without post flow can cause erratic restarts due to the oxidized or over-balled wire tip.

Even with the burn back control properly adjusted, due to operator error, an occasional quick trim of the wire may be necessary for best arc starts. But overall, when used in a production setting or in a fabrication shop, the burn back control can save on labor and aggravation.

Starting the Arc and Welding.

Starting the arc is a relatively simple process. Before beginning, the wire should initially be trimmed to between 1/4 to 3/8". Once the wire is trimmed, the gun should be firmly grasped to prevent a phenomenon often referred to as "machine gunning". A light grasp, especially at start, can cause the arc to stutter as the wire pushes back on the gun, lengthening the wire stick-out and creating an irregular start and

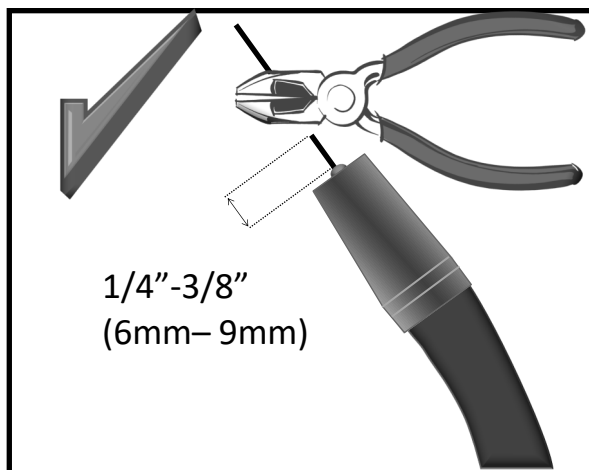

porous weld.

The end of the wire should be positioned just barely above the metal when the trigger is pulled for the cleanest start. This will position the end of the contact tip about 1/2" above the weld. The gun should be in the vertical position, with no more than 5 degrees lean in either side to side direction. Holding the wire too far off from the metal will result in rough starting and too long of wire stick out.

Once the arc has been established, the gun can then either be pushed or pulled in the direction of the weld. In either case, the gun nozzle should be positioned directly over the weld without angling the wire to one side or the other of the weld as already mentioned. The gun should have no more than 15 degrees lean pointed into (push) or pointed away from (pull) the direction of travel. In most cases a push motion is desired. However, a lot of texts offer conflicting information on whether to push or to pull the gun. In reality, both are correct if used correctly and with each having particular strength and weakness. Either one done with too much gun angle will result in undesirable results. Most open-minded people who are well versed in MIG quickly develop a sense of when to push and when to pull the gun. Even for novices, a sense of when to push and pull the gun comes quickly with a little practice. Pushing can result in shallower penetration but the molten puddle is easier to see and the arc sits easily on the leading edge. It will usually leave a aesthetically pleasing bead. However, be careful to prevent the gun from leaning toward or away from the direction of travel too much as spatter will increase and shielding gas flow may become turbulent, creating porosity in the weld. Pulling will result in deeper penetration, but can result in a narrow bead without much side fusion. It also can leave an undesirable humped appearance if not done correctly or if travel is too slow. **Whenever MIG welding with Aluminum, whether with the standard MIG gun or the Spool gun ALWAYS push the gun. If using Flux Core, a dragging motion is almost always recommended.**

Weaving (oscillating the torch from side to side in one pattern or the other), particularly a MIG bead, is a topic of controversy as much as whether to push or pull the MIG gun. Stringer beads are often best

BASIC MIG OPERATION

for novice welders. Stringers are simply straight beads that move forward with little or no side to side travel or oscillation. These will offer the soundest welds for a beginner. Stringer welds leave little or no room for contaminants to enter the weld and are the fastest to produce without creating an opportunity for cold lap. Moving too quickly however with a stringer can create undercut which will weaken the weld. The best policy is to move a slow steady speed, making sure the sides of the weld are filled. If undercut is present, it is either from too much voltage or moving before the wire has time to fill the area the arc has melted.

Think of weaving as a method of “sewing” the metal together. If weaving is of interest to you, start with the basic weave pattern. Simple weaves using one variation or the other of a cursive “e” motion are best to begin with. Other weave patterns can be used of course. C’s, V’s, U’s, Triangles and many more weave patterns can be used depending upon the application. Weaves are employed for a number of reasons. Weaves are often considered to have a more pleasing appearance and can help bridge gaps where fit up is a problem. A weave is also frequently used to manage heat build up. For example: when welding vertically weaves are almost always used to prevent the molten metal from sagging due to the force of gravity. The major drawback of weaving is that it introduces a greater possibility of getting inclusions and other forms of contamination in the weld. Properly done weaving is a valuable tool, but it must be practiced before employing it in any structural or critical application.

Metal Cleaning.

MIG welding requires a well prepped surface to obtain a sound weld. The removal of paint, rust mill scale, or other contaminate such as grease should be done before welding. Stick welding is more forgiving of rust and mill scale, but when MIG welding, contaminants will result in porosity and inclusions in the weld, weakening it. A grinder will usually prep the metal sufficiently to remove oxidation and paint. However, to remove grease a degreaser such as acetone should be used. Do not use any degreaser such as a brake cleaner with chlorinated solvents or death or serious injury may occur!









A MIG wire such as ER70S-6 or ER70S-2 includes a

sufficient level of deoxidizers such as silicone and copper that are formulated to allow it to handle minor to moderate amounts of rust and mill scale. These deoxidizers will float out most moderate amounts of contaminants out of the weld and will appear in the usual form of glassy like deposits on top of the cooled metal. They are easily brushed off before starting the next pass. They should not be welded over. Any pinholes that appear are a result of trapped gas in the weld and should be ground out before the next pass. It should be noted that some MIG wires such as ER70S-3 have low levels of deoxidizers and must be thoroughly cleaned and ground before welding.

Multiple Pass Welds.

One of the common misunderstandings that people have when beginning to MIG weld is that if the welder has the power, then a single heavy pass will do to weld up in a single pass. This is a primary way to introduce cold lap and incomplete fusion to the weld. Single pass welds should not exceed 1/4” even with the heaviest wire the welder is capable of handling. A thick pass may also begin to cool before contaminants and gas pockets have the time to float out to the surface. It’s far better to make multiple smaller passes to complete a plate weld for a higher quality result. For best results, this requires that most joints 1/4” and over be prepared with a grinder to accept multiple weld passes. The weldment edges should be ground to form a V, U or J shaped groove to create a recess where the welds can be welded one on top of another. For welding with .035” wire and under, create a bead no thicker than 3/16” in a single pass, no more than 1/8” with .030” wire, and with .025” wire and smaller no more than 3/32 for best results. This will help maintain proper fluidity of the weld and prevent gas from being trapped in the weld and give time for any minor contaminants to float out of the weld. It will also help to maintain reasonable forward travel speeds. Too slow of travel speeds will create excess build up and can tend to create cold lap at the weld toes resulting in poor tie in. One issue created with a weaving technique even if the metal deposited is the correct thickness is that it can slow the forward progress down. If weaving is too wide, one side of the puddle will cool and oxidize before the torch is brought back across to that side. This is a point where porosity and inclusions can be introduced.

BASIC MIG OPERATION

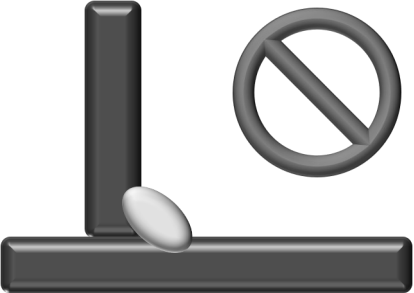
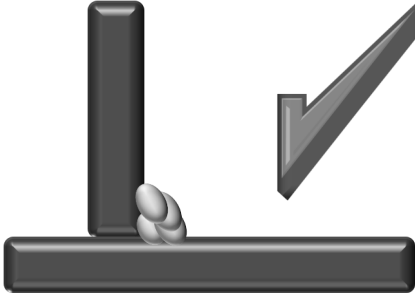
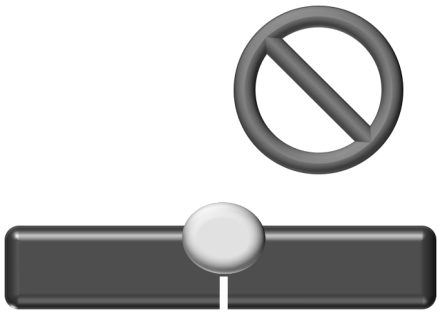
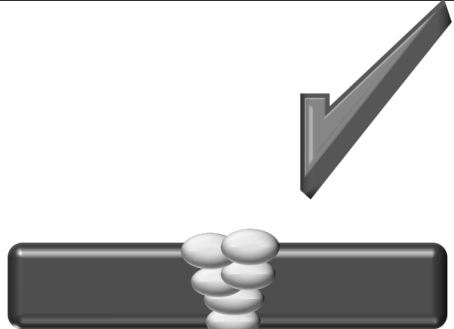

<p>V-GROOVE (60-80°)</p> 	<p>DOUBLE V-GROOVE</p> 	<p>Besides a butt joint and lap joint which are often used for thinner metal gauges, consider using one of these groove joints for best welding results. When grinding or cutting the bevels, especially with a single V-groove, it may be beneficial to leave a small land with a gap between the joint to achieve full penetration. In this case a temporary backer plate can be used to support the bottom of the weld to create the root pass. The root weld will weld the backer to the main plate. This backer can later be ground or cut off. However, in many cases a plain open root can be used as a backer plate adds to the time and labor involved. A knife edge is also acceptable so long as the joint is fully penetrated when the weld is completed. Open root gaps without a backer can range from 1/16" to 1/8" depending upon wire diameter and application.</p>
<p>U-GROOVE</p> 	<p>DOUBLE U-GROOVE</p> 	
<p>BEVEL GROOVE</p> 	<p>DOUBLE BEVEL GROOVE</p> 	
<p>J-GROOVE</p> 	<p>DOUBLE J-GROOVE</p> 	
<p>JOINT PREPARATION</p>		

 <p>≥ 1/4" Fillet</p>	 <p>≥ 1/4" Fillet</p>
 <p>≥ 1/4" Butt Joint</p>	 <p>≥ 1/4" V Joint</p>

When welding material 1/4" and over be careful about trying to put too much metal down in a single pass. Use multiple passes to complete the weld along with any necessary joint preparation especially with wires of smaller diameter. As metal thickness goes up so does the number of required passes. Depending upon the wire diameter and power settings used, a 1/4" joint may only require 1 or 2 passes, but a 3/8" joint in plate metal or pipe will require not only beveling but 4 to 6 overlapping weld passes including a cap and root pass.

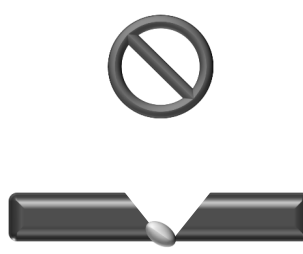
BASIC MIG OPERATION

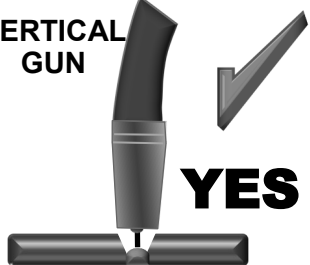
 <p>NO</p>	<p>Problem: Gun is not being held vertical from side to side. Wire is not being directed to the center of the puddle. This concentrates heat on one side of the joint and results in poor fusion on the neglected side. It also can create more buildup on one side of the joint than the other.</p> <p>Correction: Hold the gun so that the angle of the neck stands perpendicular from side to side.</p>	
--	--	---

<p>VERTICAL GUN</p>  <p>YES</p>	<p>Correct Technique: The gun is held in a near vertical position. A variance of 5 degrees or less is acceptable from side to side. The purpose is to prevent the arc from being concentrated on one side of the weld joint or the other. This balances the heat on both sides of the joint and keeps the bead centered. Don't confuse this with push or pull angle in the travel direction.</p>	
--	---	---

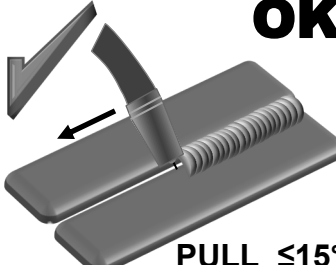
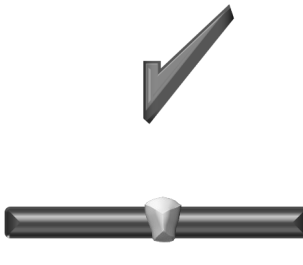
 <p>OK</p> <p>PULL $\leq 15^\circ$</p>	<p>Correct Technique: The gun is angled toward the back of the weld when traveling forward. This angle should not exceed 15 degrees. This provides a narrower but more deeply penetrating weld. Use this method when Flux Core wire is being used. Use this method where the unit may be reaching its maximum welding capacity. Not for use with Aluminum wire.</p>	
--	--	---

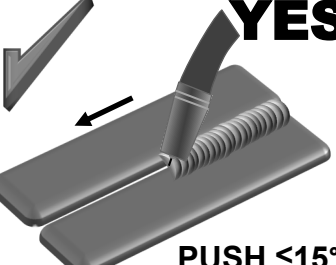
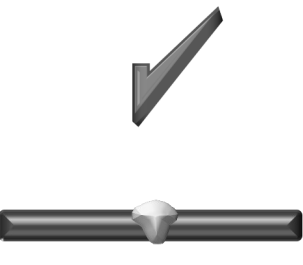
 <p>YES</p> <p>PUSH $\leq 15^\circ$</p>	<p>Correct Technique: The gun can be angled toward the front of the weld when traveling forward. This angle should not exceed 15 degrees. This provides a wider and generally more pleasing weld. However it is shallower penetrating. This method typically allows a much better view of the arc. Use for most types of welding unless deeper penetration must be achieved.</p>	
---	---	---

BASIC MIG OPERATION

	<p>Characteristics: Concave weld, poor filling, possible undercutting resulting in weak weld.</p> <p>Possible Causes: Voltage too high, not enough wire speed, too short of wire stick out, wrong gun angle.</p> <p>Remedy: Decrease voltage, use push motion, increase wire speed.</p>
---	--

	<p>Characteristics: Small Convex weld possibly with bulging sides/cold lap and/or an inconsistent arc.</p> <p>Possible Causes: Not enough Voltage or Amperage. If weld is ropy and thin without bulging at the toes, travel speed is too fast or using a pull technique.</p> <p>Remedy: Increase voltage and amperage, slow down to fill joint more. Use push technique.</p>
--	---

	<p>Characteristics: Large convex weld with bulging at toes, weld legs exceed thickness of the metal being welded.</p> <p>Possible Causes: Not enough voltage, too much wire speed, overfilling due to too slow of forward travel speed, and/or poor weaving technique.</p> <p>Remedy: Increase voltage, increase forward travel speed, reduce weaving width.</p>
---	---

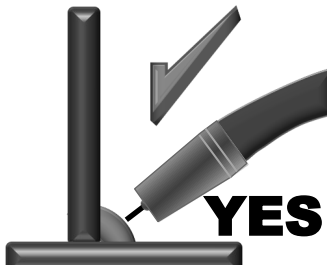
	<p>Proper Weld Characteristics: Weld is slightly convex, weld legs (vertical and horizontal width of weld) are equal in length and match the thickness of the metal being welded. No traces of undercutting, Proper tie in of the weld at the toes with no cold lap. Weld is not overfilled or under-filled with no significant amounts of spatter, soot or contaminates around weld. Weld is not oxidized and is bright.</p>
---	--

PULSE MIG OPERATION

The Power i-MIG 275P pulse design is a single-pulse wave form that features full manual control of the pulse parameters. This means that the pulse action of the unit varies between two user defined levels of voltage while welding. To understand the Everlast Pulse MIG design and setup, it is important to recognize and discuss basic types of Pulse MIG welders to help you understand how the Power i-MIG 275P is similar and different in design, setup and operation.

The Types of Pulse MIG Welders. There are many different types of pulse MIG welders. Every brand has their own type or types of pulse MIG welders. Over the years, pulse MIG welders have changed in design and function and multiple types of Pulse MIG may be represented under one brand. Many times it is difficult to pinpoint the differences in the pulse function from generation to generation or model to model as many companies prefer to explain the effects rather than the functions. There are nomenclature differences as well from brand to brand and model to model. One function may be called by one name by one company, while the same function is called by another name by another company. Some offer more fine tuning control over the parameters than others. Over the years pulse MIG welders have definitely evolved. This has created a lot of confusion and misunderstanding in the industry by users about what pulse MIG welding is and what it is capable of. Training seminars provided to dealers of one type of brand may indeed teach a Pulse MIG product feature is unique or special by trademarking a name of a control while another brand has the same exact feature but is called by another name. It has led to a lot of confusion in the industry. However, to be clear, there are two

major categories of pulse MIG welders: single (or simple) pulse, and double (or pulse-on-pulse) pulse. With most single-pulse MIGs, the current is pulsed between two preset current values, creating a simple, square type of DC wave form. With a double-pulse type of MIG, the unit actually pulses between 4 pulse current levels, with at least two low pulse values and two high current values. In the most simple terms, this creates a stepped wave form which looks and sounds different than a single pulse, simple up and down wave form. The main advantage of the double pulse MIG, when it is properly set-up, is a clearly defined ripple similar to what you'd find in a corresponding TIG weld. The way these current values are pulsed can also vary.

The Basic Theory and Purpose Behind Pulse MIG. Regardless of the type of pulse MIG we are referring to, *most* pulse MIG welders are cycling several times a second between high and low values of current (amps). Many single pulse MIG welders cycle between 20-500 Hz. This allows good control over the heat being put into the weld. The basic reason for using a single-pulse MIG is to prevent overheating of the weld metal while maintaining a rapid deposition rate without compromising fusion. Single-pulse MIG welding is mostly done in pulsed-spray mode. Pulsed-spray is a modification of the Axial spray mode, where the metal actually pinches off before the wire touches the weld puddle, without shorting the arc. Axial spray is accomplished by using higher volts and amps than would be used in a short circuit transfer process. Historically, the most common applications for Pulse MIG welding are in aluminum or stainless. Currently, though, single-pulse MIG welders are being used braze with Silicon bronze in auto body repair shops.

PULSE MIG OPERATION

But pulsed-spray is also used with mild or carbon steels to allow out of position welding and to maintain production welding speed levels. In comparison, Short-circuit transfer is a cooler and slower MIG process where the MIG wire has to extend out from the contact tip into the puddle before the arc shorts and the wire melts and is forced violently into the puddle several times a second. Pulse MIG combines both processes. Most single-pulse MIG welders, are in spray mode for most of the pulse cycle, but drops below the spray transfer threshold into the short circuit or globular transfer range long enough to provide a cooling effect on the puddle, but not long enough for any metal to transfer into the puddle. In effect, the goal is to transfer one droplet of metal per pulse cycle. Standard axial-spray MIG, although the fastest method of welding, is not intended for out-of-position-welding as the puddle is quite hot and will not hold in place when used overhead or vertically. Pulsed spray helps to resolve this issue. In steel and stainless use, whether in Pulsed spray or Axial spray special gases which enable a lower transition point into Spray should be used to be controllable and practical. These gases are much higher in Argon (90% or greater). As for aluminum, most MIG welding of Aluminum is already done in spray mode to prevent incomplete fusion. All MIG welding is done, regardless of transfer method is commonly done with Argon, or more rarely, an Argon/Helium mix.

Most double Pulse MIGs are largely used for Aluminum welding, though they can be used for Stainless or Steel welding. The double Pulse MIGs, are completing full cycles at a frequency of 5 Hz or less (though there may be many steps within one full cycle). This is the

type of Pulse MIG commonly associated with a "TIG" look, with well defined ripples. The heating and cooling is done at a level and speed that allows the weld to pool and solidify between the high pulse stages of the pulse cycle much more so than single pulse MIGs. While heat management is the goal, they are most sought after as they can mimic the style and look of TIG while offering an improved speed over TIG without the same required level of skill. The single pulse is not comparable in look to the look of the double pulse MIG weld, even though some refinement of the weld is possible in a single pulse MIG.

Both pulse types have many variations from brand to brand and model to model. But most modern forms of pulse are complicated to set manually, with most of the parameters taken out of the control of the user, and only allow minor fine tuning by the user, if any at all. The controls that do exist in these pulse models are often not clearly defined in their function or adjustment values. Older Pulse MIGs from generations ago, allowed more adjustments. However, these older transformer based and early inverter based pulse MIGs were often too difficult to set without considerable training and experience. New models are controlled by digital programs which are programmed at the factory for a one-size-fits-all approach based off of testing and user experience. These synergic versions keep frequency, voltage, inductance, wire speed and a few other parameters all within a tightly controlled range that prevents the user from going too far astray. While this is a great development that helps the untrained welder to learn and setup the equipment quickly, the lack of commonality in terms, clearly defined references to values, and even differences in

PULSE MIG OPERATION

the nomenclature make employing Pulse MIG welders for jobs that require strictly defined parameter values quite difficult. What's more, settings are hard (if not impossible) to transfer across brands or model variations if a procedure has been qualified using one brand or model of welder.

Everlast's Pulse MIG Design. Everlast's approach to pulse MIG design is a bit different than other brands and models of pulse MIG welders. It can be compared to other types of single-pulse MIG welders only in the fact that the pulse wave shape is considered "simple" because it is pulsing between two defined values. However, the key difference between Everlast's version of a single-pulse MIG and other versions of pulse MIGs is that Everlast pulses voltage instead of pulsing current (Amps). By pulsing voltage, you are managing heat by creating an average voltage value that preserves the best characteristics of the lower voltage values and of the higher voltage values. Voltage, as used in the MIG welding process, controls the arc length, which in turn controls arc cone diameter. A wider arc cone will create the impression of a "hotter" weld as the wire is burning back to a more distant height from the weld puddle. A higher voltage will also allow the metal to flow more readily (wet-in), leading to a wider, flatter bead. But voltage set too high can also be a contributor to spatter, burn through and arc instability. A lower voltage value can help control burn-through wet-in, and can prevent too wide of a weld bead. But if the voltage is too low the bead profile may be too narrow and too high (often referred to as a ropy weld). As you use the Everlast welder in pulse mode, the average voltage value is roughly between the two voltage values you have selected. The idea is to

gain the arc control provided by the lower voltage while gaining the wet-in property and speed of the higher voltage. The speed at which the pulse operates (frequency) yields the added bonus of more a directable arc and a more desirable bead shape. By pulsing voltage, pulse spray mode is still attainable but the user will set a sub-spray voltage for the base pulse voltage (expressed in percent of welding voltage) so that the puddle will solidify without the weld puddle flowing uncontrollably. Pulsed-spray is excellent an excellent choice for welding out-of-position. When compared to standard axial spray the pulsed spray is superior since axial spray is usually limited to welding in the flat position only.

The Everlast Pulse mode is not considered synergic. In other words, it does not have a factory programmed set of parameters which limits the user's control over while you adjust all parameters through one control knob.

While a non-synergic pulse may seem initially to be more primitive, this actually allows the user to take full control of the pulse and provides easily repeatable weld parameters, that are user definable and allow it to be used where parameters need to be qualified, quantified or otherwise, tightly controlled.

Everlast Pulse Settings. The Everlast version of Pulse MIG has 3 basic controls for pulse.

When judged by itself, with all other MIG pulse parameters fixed at the same settings, each pulse control function has a specific effect on the weld. But each pulse function can also have an overlapping effect of another pulse function. This depends upon how the individual pulse function is adjusted relative to the other two remaining functions.

Though this may sound confusing at first, a

PULSE MIG OPERATION

little practice will make sense out of it. The main thing to keep in mind though, is that a change in each individual function has a definable effect when the other two pulse functions remain unchanged in their value during adjustment. But, correct combination of settings can affect the weld similarly to a different combination of settings. Also, the effect of any one pulse function can be effectively muted **or** exaggerated by setting of one or combination of the remaining two function's parameters to an extreme low or high value. An extremely exaggerated setting of any one function or combination of functions may also result in an unusable, uncontrollable arc or weld puddle. For this reason, make slight adjustments when tuning the pulse. Adjust the pulse no more than a few percent or hertz at a time. Usually, increments of 5% Pulse Voltage, 5% Pulse Time on or 25-50 Hertz changes at a time is sufficient for coarse tuning of the pulse settings during setup. To further fine tune the pulse after an approximate setting is found, cut the adjustment increments by half or more. Using a wider adjustment increment than this will often cause you to skip past a ideal parameter setting without giving you an indication that you may be nearing the "sweet spot" for the selected function. Always adjust one parameter at a time before testing the results. Start the adjustment process by tuning the pulse voltage. The pulse voltage is the primary pulse function that all the other pulse functions skew or adjust. By starting the pulse adjustment process with the Pulse voltage, setup time and effort will be reduced. After that proceed to pulse frequency, and then, of course to pulse time on setting, adjusting it last. By trying to change too many variables at once, you will usually not be able to fine tune the pulse to the best settings.

Remember, the pulse feature is intended to be used to control heat input and improve out of position welding capability without creating large sacrifices in travel speed or penetration. Even before attempting to set the pulse, begin by setting wire speed feed/amps to a known good value for the wire diameter and metal thickness. Use a welding calculator if necessary (many can be found online), or use the wire manufacturer's suggested settings found on the packaging or in their published materials. In the absence of these references, if you do not know an approximate setting for wire speed, you can use the formulas suggested earlier in this manual to determine the approximate wire feed speed/amp value. **Wire speed should only be adjusted again after no workable setting for the pulse voltage has been found or only adjusted slightly to further fine tune the settings after the pulse is performing well.** Below you will find the essentially four basic pulse settings outlined and their basic effects on the weld identified along with additional features affecting the performance of the single-pulse feature of this unit.

1. **MIG Pulse Voltage (Peak) and MIG Base Voltage (%).** In theory, Voltage controls the arc length, which contributes to how wide the arc cone is which spreads the heat out over a wider area. **In the simplest terms, Voltage affects the bead height and width and in general "wet in". If you increase the Voltage, you will get a wider, flatter bead.** Too much Voltage is undesirable, causing an uncontrollable arc, spatter and undercutting. The Everlast type of pulse allows you to set a higher Voltage than normally suggested by providing a peak MIG Pulse Voltage and a lower Voltage value referred to as base Voltage (%). The base Voltage is the bottom portion of the

PULSE MIG OPERATION

pulse wave. This provides lower than typical heat input, while still providing adequate wet-in characteristics and a narrower arc cone. As briefly touched on earlier, the Everlast version of MIG pulse pulses Voltage, instead of current. For discussion purposes, the "MIG pulse Voltage" listed on the machine panel is also called the "peak" Voltage. The MIG pulse volts setting is actually the high voltage point of the MIG pulse cycle. The actual base Voltage function itself is displayed as a percentage of the peak Voltage and is the low point of the MIG pulse cycle. The base Voltage range of adjustment is from 10% to 99% of welding Voltage. In general though, a good starting point for the pulse base Voltage is around 70%. The goal of adjusting the pulse Voltage is to positively influence the "freezing" property of the weld puddle without losing too much fluidity. Raising the pulse base Voltage value will increase puddle fluidity and wet-in while lowering the pulse base Voltage will generally tend to make the puddle freeze much faster. Keep in mind, these are the general effects that you will notice *if all other parameters are kept the same during adjustment*. Setting the base Voltage percent correctly also depends upon correctly setting the peak Voltage correctly. Commonly recommended welding voltages for standard MIG welding do not often apply. Usually, a higher peak pulse Voltage is used than is used for non-pulse welding, for the same g wire and metal thickness. This is needed to maintain penetration and weld speed. Even on thinner metals, an increase of 10-30% over typical Peak Voltage is a recommended starting point for setting the welding Voltage. On thicker metals, a greater

increase over typical suggested peak Volts may prove helpful. But at the very least, consider 10-30% additional Volts (over the standard recommended non pulse volts) as go-to starting point when setting peak Volts. After setting wire speed and peak Voltage, set base Voltage to 70%. Fine tune it by ranging up or down at increments of 5% at a time, while running test beads during the adjustment process. If the weld puddle is too fluid, try adjusting the pulse base voltage first. If the setting is not forming a good puddle or it seems sluggish or the weld bead is piling up with poor penetration/fusion with excessive spatter, consider adjusting the peak Voltage up a little more before going above 80% base Voltage. This is because the freezing effect begins to diminish as peak and base voltage gap narrows (when all other settings remain unchanged). This is not to say the on some occasions, a base Voltage setting of greater than 80% may not prove useful. However, in general, as the Voltage differential of the pulse is reduced, you'll find that other settings may not have as much effect when trying to fine tune the pulse unless the rest of the pulse parameters are adjusted to more extreme settings. But by then, you may find the pulse is no longer smooth or stable. *On the first round of adjustments, set the Peak Voltage and Base Voltage once, and then proceed to adjust pulse frequency and then to pulse time-on. After that, return to fine tuning the Peak and base voltage if needed.*

2. **Pulse Frequency (Hz).** The frequency of the pulse is defined as the number of pulse cycles completed in one second. This is sometimes referred to as PPS, or pulses per second. When dealing with frequency

PULSE MIG OPERATION

settings on the pulse, you will find that desirable frequencies have a fairly broad range. To simplify pulse frequency adjustment, start with the maximum pulse frequency of 250 Hz, adjusting downward in 50 Hz increments at first. Once you feel you are close to a frequency you like, halve the adjustment range to 25 Hz increments. Then, further fine tune up or down in 5 Hz increments. Following this adjustment model will help you expedite the setup process. The pulse frequency will change the tone of the arc. You should hear a slight buzzing sound coming from the arc, similar to a sound of a bumble bee. The pitch of the sound will go higher as the frequency is increased. And, of course, the pitch drops as the frequency is decreased. In practical terms, the pulse frequency effects the pulse arc stability and concentration. By adjusting the pulse frequency higher or lower, the arc cone shape and stability will be affected. Typically, when the frequency is increased, you will a narrower arc cone and you may notice changes in the puddle agitation. You'll also see the bead is more tightly formed and penetration is pinpointed. The lower the pulse frequency, the arc cone will widen. A lower pulse frequency will result in a wider more fluid puddle as well. Lowering the pulse frequency when the pulse balance is set to approximately 50% (setting used as an example only) will increase the wet-in of the filler. Wire diameter affects the desirable frequency of the pulse. Smaller diameter wires will work better on lower pulse frequencies for the same given thickness of metal being welded. Thicker wire diameters may seem to work better at higher frequencies. However, this com-

ment is also based off of pulse voltage and pulse time-on remaining unchanged during pulse frequency adjustment. A change in one of the other two main settings may affect actual desired pulse frequency. The goal of setting the pulse frequency is to develop a controllable arc, bead and puddle. If welding on thin metal, the goal is to maintain wet in and travel speed without burning through. When using a thicker wire, you'll want to use a higher pulse frequency to prevent burn through. If stubbing of the wire is felt between pulses, or the puddle is overly agitated by the action of the wire digging into the puddle, the pulse frequency has dropped too low to allow the wire to properly burn off. Either that, or the welding voltage or pulse voltage is set too low. If a low pulse frequency is desired, then a higher pulse voltage percent should be used, providing the welding voltage is high enough. If raising the welding voltage/pulse voltage doesn't solve the stabbing/over agitation issue, decrease wire speed slightly or raise pulse frequency until this issue disappears. Puddle agitation can be useful when used moderately, but too violent of agitation can create defects in the weld and poor or irregular fusion. Even though low pulse frequencies are allowed to be selected, general purpose welding settings below 25-30 Hz will rarely be useful. However, it is good to test and experiment below this range so that you will see the effects and be able to gain valuable reference points when adjusting the pulse in the future.

3. *Pulse Time-On (%)*. Pulse Time-On is expressed as a percent of time of one pulse cycle that the pulse spends in the Peak voltage stage of the cycle. This is some-

PULSE MIG OPERATION

times referred to as pulse balance, as it indeed can be used to “balance” the time the pulse spends in base and the peak stages. Always remember that pulse time-on only has a specific observable effect on the weld puddle if the other two settings remain unchanged while the pulse time-on is being adjusted. Increasing the pulse time-on will result in faster wet in, but can lead to overheating of the weld metal and filler wire if adjusted too high. Adjusted too low, the weld will become cold and the arc may become rough. When welding with a low **welding voltage and or low pulse frequency**, the arc may appear to go completely out between the pulses if the pulse time-on is not adjusted to 80% or above (or if the pulse frequency is not increased to above 20-30 Hz.) This will provide for a majority of peak voltage time during the weld, but still render the definite rapid cooling effect needed for welding thin materials. For general purpose welding, select a value of somewhere between 50% and 80%. If welding at a higher welding voltage, you may find that a lower pulse time-on value offers a greater freeze effect. **Note: if you are attempting to use this for pulse spray mode, your pulse time-on value combined with your frequency setting should roughly equal one droplet of filler metal per pulse cycle for best results.** Admittedly, this may not be a measurable to the naked eye. However, when the pulse spray mode is correctly set, you will be able to see the effects and the actual transfer of wire across the arc in the form of fast-moving molten droplets without the wire digging deep into the puddle or cracking. More simply put, the pulse spray mode will be better if the time-on is

set for a briefer period of time rather than a longer period of time to prevent the wire from being fed into the puddle as it crosses the threshold into the colder portion of the pulse cycle (short circuit). Pulse time-on is critical to determining how much wet-in the peak stage of the pulse is providing. It contributes to travel speed as well. Increasing pulse time-on will increase fluidity and travel speed. As a good starting point for all types of pulse use, pulsed spray or short circuit, start with a setting of 50-75%. Begin at your chosen setting and slowly increase the setting values. Pulse time-on settings below 50% will generally be rarely used. Lower pulse time-on settings between 75% and 50% are useful in controlling warping. But again, that is going to be dependent upon the application and the performance goal of the user. Some experimentation below the 50% mark may prove useful in some circumstances.

4. *MIG Inductance/Arc Force (%)*. Even though Arc force/Inductance has already been covered in this manual, this will ultimately prove helpful in the final stage of tuning the pulse. For steel/stainless use, the inductance should be set at 65-70% **before** pulse adjustment is made. Then after all adjustments are made, use the inductance control to improve arc characteristics. Adjustment of only 1 or 2% can make a difference when welding on thin gauges of metal. As an example, on stainless, the puddle is typically defined as sluggish and lazy, making everything in the puddle seem cold. However, if too much voltage is used to make the bead wet in faster, the surrounding material may overheat and warp. In these cases a faster travel speed is not supported due to slow

PULSE MIG OPERATION

puddle development and behavior. Increasing arc force to 90% or more in stainless applications will actually help to reduce puddle sluggishness and increase travel speed. For aluminum, the inductance settings are dependent upon the filler wire type.

5. *MIG Gas.* While MIG gas doesn't directly control pulse, it does have a significant effect on pulse settings. Gas type and flow rate do have profound effects on heat development in a puddle. If you desire to use the pulse-spray mode, you will need to select a MIG gas blend that is greater than 80% Argon (90% or greater is preferred), with the balance being CO₂, or O₂ if welding steel. Aluminum will always require 100% argon regardless of whether standard, synergic or pulse mode selected. As for stainless steel types, several gases may be selected, but be sure they are rated for the type mode you wish to perform (Axial-pulse-spray, short circuit, or short circuit pulse.) A standard Tri-Mix of helium (65% or greater), with balance argon and CO₂ or blends of 98/2 Ar/O₂, or 98/2 Ar/CO₂ great for general purpose welding of stainless. But for welding thin steels a trimix with some helium, usually around 35% will be the best bet. The lower Helium percentage reduces the heat of the arc without compromising the shielding properties needed in stainless to prevent sugaring and granular development. The lower Helium trimix is much better for thin gauges of heat sensitive stainless while using pulse. This type mix can be found in a proprietary "Gold" trimix blend recommended for welding stainless or can be locally mixed. This is also more economical to use since the higher helium level version of

trimix is considerably more expensive.

PULSE WORKSHEETS

Use the following worksheets to save and record your pulse settings for different metals and wire diameters. Or, you may use it to create your own additional spread sheet of settings. Consider using the program memory to save your pulse settings. This is important to ensure rapid setup and repeatability of detailed weld parameters of the pulse. Once the settings have been saved, record the basic settings in the work sheet in case you accidentally save over a favorite program. The following pages can also be used to record settings that you have tried that didn't work so that you can help determine a pattern of settings that are most useful to you.

Special Notes Concerning Operation.**1. Shielding Gas Selection for MIG and TIG.**

While welding aluminum with the Spool gun or MIG gun you must use 100% Argon. You cannot use a mix as you would with steel or stainless. For Steel or Stainless, there are a variety of gases that are used. The type of gas used with Steel or Stainless depends upon whether you are using short-circuit transfer, or spray transfer. In general, the best general gases mixes for welding with Steel are gas mixes that are less than 80% Argon with the balance CO₂, or CO₂ and O₂. A Common mix, usually referred to as a C25 mix, (75% Argon, and 25% CO₂) is typically the most economical of the steel gas mixes. 100% CO₂ is permissible as well, and is the most economical option for steel welding. However, more spatter and less aesthetic welds will result, requiring more labor during cleanup. For Spray-Transfer, or Pulse-Spray transfer, gas mixes with greater than 80% Argon content is recommended. Common spray transfer gases for steel are 90/10 Ar/CO₂, 95/5 Ar/CO₂, 98/2, Ar/CO₂ or 98/2 Ar/CO₂. Some welding suppliers also suggest Trimixes of Ar/CO₂/O₂ for spray transfer or pulse spray transfer welding of Steel. For Stainless, there are several recommendations for welding with stainless whether in Short-circuit transfer. But there is mixed consensus on the best gas for use for short-circuit, Pulsed-spray transfer and Axial-Spray transfer. Stainless develops a more sluggish puddle and wet is not as smooth and easy flowing as steel or aluminum. 98/2 Ar/CO₂, or 98/2 Ar O₂ is often recommended for spray-transfer welding when economy is needed. In fact other less Argon rich blends are sometimes recommended, and it is possible. But when

more CO₂ is added, the rust resistance of stainless goes down due to the added carbon content. Ideally, there are several Tri-gas mixes out there that are well suited to welding stainless. These include the addition of Helium to the mix as either the primary or secondary component of the mix. The Helium tends to help improve wet-in and fluidity of the puddle, but a higher voltage may be needed to weld if the Helium content is too high. It is also much more expensive. Welds made with Tri-gas mixes tend to hold their rust resistance better. But to reduce the heat that is put into the weld, and reduce warping, there are stainless tri-gas mixes on the market that have a content of approximately 35% or lower Helium. These still are great for preserving rust resistance of the stainless alloys. Wet-in is still excellent and cost is much lower than higher Helium content blends. While welding in any of the TIG modes you must also weld use 100% Argon for any metal type. (This unit is not designed to weld aluminum with TIG, but if it could 100% Argon would still be used.) In some cases, blends of Ar/He may be used for TIG for welding thicker metal thicknesses, but the cost to do so is quite high as He/Argon mixes are expensive by comparison.

- 2. MIG Welding Aluminum.** While welding aluminum with the Spool gun or MIG gun you must use the next size up tip or a special oversize tip for the wire because the heat will cause the aluminum wire to swell and it will either drag or seize in the tip, due to the dissimilar expansion rates of the copper tip and aluminum wire. If you are suffering burn backs while welding Aluminum (and in some cases stainless), change to a larger tip, and reduce burn back time. While welding aluminum with the MIG process, best results are

STICK OPERATION

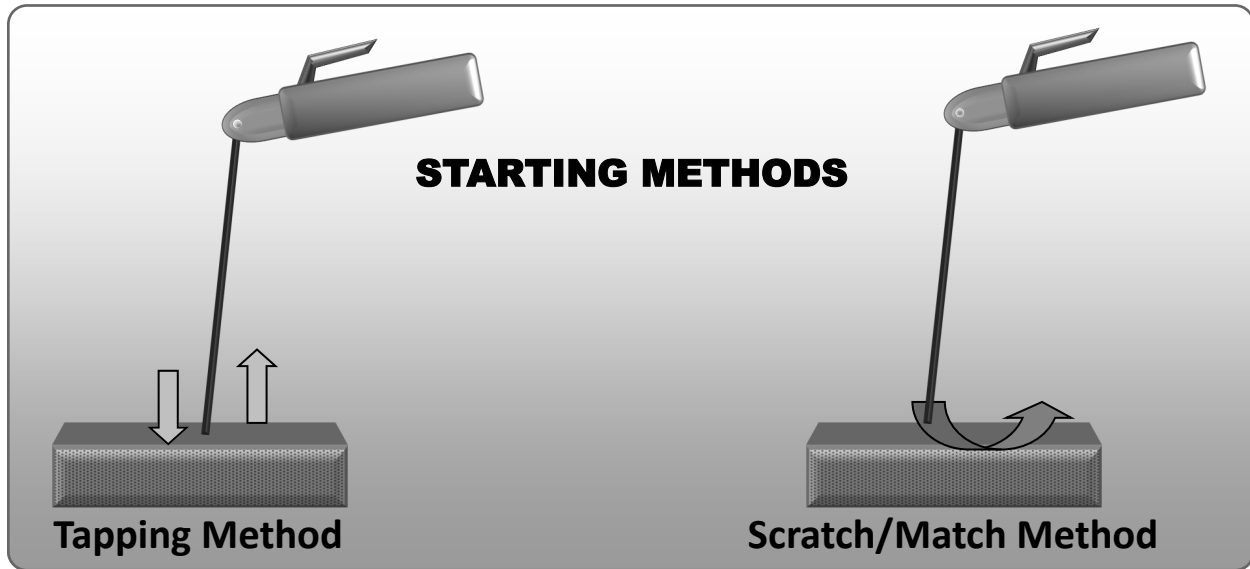

Striking the Arc

1. Make sure the unit is turned on and the startup cycle has finished.
2. Select the Stick icon on the Process Selector.
3. Make sure the electrode holder is in the Positive connector and the work clamp is in the negative connector.
4. Select the Amp level desired. Use the guide on page 16 to determine approximate amps suitable for the rod size selected. You should consult the welding electrode manufacturer's recommendation for proper amperage as the ultimate authority. No voltage adjustment is available. Select Hot Start Time and Hot Start Amps % (Intensity) to improve starting reliability.
5. Use the arc force control to select the desired arc characteristics, creating the desired arc characteristic and amp response needed to maintain the arc. Cellulose electrodes may not have the same arc force behavior as other welding electrodes, but each brand and size will weld a little differently. Typically rods such as the E6011 will require a setting over 50% for best results. The arc force control setting will vary from person to person as well, with different rod angles, positions, and arc lengths all factoring into the arc force control performance. If you are new to using a transformer welder, there are some aspects that will seem different. One of the main ones is that the arc is better controlled in most situations by "pushing in" when the arc seems to get weak or unstable and the arc force will kick in as the voltage drops. Holding too long of an arc will signal the inverter to shut down and to terminate welding output. This threshold is shorter than most transformers, and an extremely long arc cannot be maintained. However, with a little practice, the arc will be easy to manage.
6. Strike the arc with either the tapping method or the match strike method. Beginners usually find that the match strike method typically yields the best results.

NOTE: Pay particular attention to the Arc Force setting as it affects the aggressiveness of the arc and the amp response. Set the Arc force to approximately 30-50% and readjust it from that point to find the optimum setting. Adjust in increments of 5% up or down from there to obtain the best results. Usually, an increase in the arc force for cellulose based flux welding rods is helpful. Lowering the Arc force setting is generally desirable for rods iron powder/Titania based flux. Too much arc force will create overheating of the welding rod, and even cause them to flame up. Too little can lead to sticking and arc snuffing. Use the Hot Start features to improve arc starting and cut down on failed arc strikes. Hot Start Amps refers to the % over the set amps that the amps will be boosted during arc striking until the arc is established. Hot Start Intensity controls the amount of time that the Hot Start stays engaged after the arc is struck. Start by setting Hot Start to somewhere between 30% and 50% and set hot start time to .2-.3 seconds. Adjust in increments of 5% up or down to obtain best starting results.

When welding, the weld will be slower than MIG speed. One of the most common mistakes for users transitioning from MIG to Stick welding is the travel speed. Allow the metal to fill the puddle as the rod travels forward. Be sure to try to separate the difference between the slag and the molten pool of metal. The slag will coalesce behind the puddle if travel and rod angle is correct. Do not let the slag travel in front of the puddle. Keep the top of the rod inclined to the direction of travel around 10-20 degrees while welding in the flat position (Electrode holder should be in front and inline of the puddle). To begin, simply start the arc, and then drag the rod slowly and carefully along the metal, allowing the rod flux to provide a standoff between the metal filler and the puddle. Be sure to keep feeding the rod steadily downward into the puddle as the rod melts. In the case of E6011, a slight stepping motion in front of the puddle about 1/8"-1/4" in front of the puddle can be used as a key hole opens up in the weld joint, ahead of the puddle. This is also called "whipping" the rod. Do not flip the end of the rod away from the puddle in a arc motion or the arc may terminate while using E6011 or similar cellulosic rods. When experience is gained, numerous manipulation methods may be used with rods such as E7018, 7014, 6013, and 7024. Weave the rod no more than 2.5 times the width of the welding rod. To begin weaving, weave small, tight patterns similar to C's, cursive E's, V's, or even figure 8's.

- achieved by using a dedicated stainless steel brush to remove the oxide layer and using acetone or aluminum cleaner before welding to remove any residues. Even though aluminum may appear shiny and clean, it still has an oxide layer and a thin layer of oil left over from the manufacturing process. Some soot will appear in most Aluminum MIG welds but if a lot is noticed, you have either contaminated metal, or insufficient gas flow. You can also induce turbulence by having too much of a torch angle. Start with a 90 degree angle and then lean the gun slightly (about 15 degrees) to the “push” position. Welding aluminum is not typically a short circuit process. It is a spray transfer process or a Pulsed-Spray process. Spray and Pulsed-Spray transfer are processes that are used to weld many metals, but in Aluminum it must be used to obtain the most sound quality welds.
3. **Spool Gun Selection.** When using the optional spool gun, the amp/wire speed control is controlled on the spool gun. You must purchase a MTS version of the spool gun to operate correctly. You may purchase a compatible spool gun directly from Everlast for your unit. For the best match-up, we recommend the Parker
 4. **Flux-Core Operation.** Flux-Core welding requires the use of serrated drive rollers. These grip the wire and feed it correctly at a steady speed. Flux-Core drive rolls are available for purchase as an optional item. Full time use of Flux-Core filler wire will require the purchase of a flux-core specific gun. Everlast does not supply this type of gun, but many after-market Gun suppliers can supply a Flux-core gun with a Euro-connect fitting and will work. Part-time or occasional Flux-core use with the standard
 5. MIG gun is acceptable as long as the nozzle is kept free of spatter.
 5. When running this unit on a generator, the manufacturer of the generator must certify it as a having “Clean Power” output. This means the unit produces a truer sine wave and is not a modified sine wave generator and is largely free from harmonic distortion. A clean power generator is usually listed as such, but the manufacturer of the generator should be able to clarify the clean power status of the generator through the technical department of the generator manufacturer. Everlast does not keep a list of approved generators nor does it make endorsements of generators that are listed as clean power output. The generator power requirement for this unit is 8500 continuous watts with a surge capacity of 12,000 watts required.
 6. **MIG/TIG 2T/4T settings for the sequencer.** For TIG, the 2T/4T feature allows operation without a foot pedal. In many circumstances, a foot pedal is not practical for use. So, the 2T/4T function has been created to allow sequencer programming of the welder to simulate the activities of the foot pedal while providing more accurate control. In TIG mode you are controlling Pre-Flow, Post-Flow, Up and Downslope of the Amps with the sequencer. For MIG, the 2T/4T feature allows control of the sequencer programming giving the user the choice of operation styles. This allows the unit to be operated without keeping the trigger pressed. This allows the user to improve productivity while reducing fatigue. In some circumstances, it allows the unit to be used with some auto-welding machines. When used in MIG mode, you are controlling the Pre-flow, Post-Flow, Up and downslope of the Volts with the sequencer. **NOTE: For MIG operation, the**

user must choose between the two.

There is no other operation style similar to a foot pedal for MIG. The “T” refers to the number of “travels” of the remote switch required to operate the programming of the sequencer. 2T is essentially a “press and hold” operation and all programming is cycled automatically. Releasing the switch begins the final stage of programming. 4T operates differently in the fact that each touch activates a different stage of the programming, allowing for greater control. In 4T mode, while welding at full selected value (MIG: Volts, TIG: Amps), no finger contact with the switch is required. Following the graphic lines below, you can visually trace the activity and function of each part of the welding cycle. In either 2T or 4T operation the programming can be reset to “upslope” before reaching the end amp stage by pressing the switch once more. See the graphics below for further explanation. The up and down arrows indicate the switch travel direction.

2T Torch Operation Effect on Weld Cycle. (Start/End Values are fixed.)

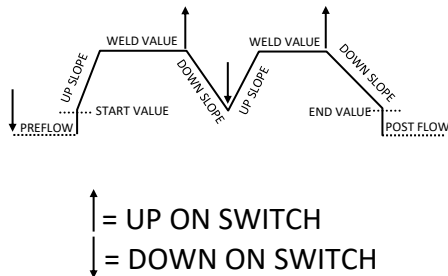

4T Torch Operation Effect on Weld Cycle. (Start/End Values are fixed.)

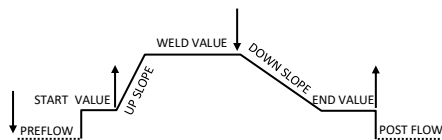

Basic TIG Operation

General Setup. The process to set up the welder for the basic TIG mode is much less involved than for basic MIG. TIG voltage is not conventionally adjustable and is a product of the arc length. This is not to say voltage is not important to TIG welding, but it is not something that can be adjusted on the unit. In practical terms, voltage is not a concern to the user as it is self regulating. Amperage however, is adjustable. Setting up Amperage correctly for TIG is different as there is no “sound” to listen for. But for each given thickness of metal, there is an acceptable range of adjustment for TIG. Traditionally, a general rule of thumb for TIG setup is to set approximately 1 amp for every .001” of metal thickness. For modern inverter technology, that may be too many amps in all but the thickest weld material, particularly for a DC inverter TIG welder such as this one. In many cases, you will only need to use 75% to 80% of that amperage. But if you are setting up the unit to use a foot pedal, use the rule of thumb to begin with as you can always back off the amperage as you are welding by letting up some on the foot pedal. For basic details for setup, consult the guide on pages 15 and 16. Also much of the information in the “Basic MIG Operation” guide in this manual is useful and applicable for TIG welding. Pay particular attention to the subsections about metal cleaning and multiple pass welds. If needed, there are several online TIG apps and calculators that you can give you starting points for welding almost any thickness as well as general settings for tungsten size, and gas flow rates. The general information found on pages 34, 35 and 36 can also be applied to basic TIG welding procedures. Use the information on the following pages to help guide you through arc starting and tungsten preparation.

Welding. If you are new to TIG welding, it’s important that you understand that TIG welding is much slower than MIG or Stick welding. It requires patience and steady practice to become proficient at TIG welding. However, most people can achieve some level of proficiency at TIG welding if they are patient, and are willing to analyze and adjust the way they are welding. To start welding, set the amps desired for the metal thickness you are about to weld. Before striking the arc, make sure the shielding gas is on, and properly set. Also adjust your Tungsten stick-out to about 1/8”-1/4” to begin with. Then follow the arc starting methods on the next page. Once the arc is started, keep a loose but sure grip on the TIG torch to prevent cramping. An underhand hold is good, similar to the way a pencil is held. A foregrip may be used as well, but offers less fine control at the beginning and requires more propping to keep the torch steady. Practice running slowly without filler metal first. Keep the torch head inclined away from the direction of travel, so the Tungsten stays just above the puddle, pointed toward the front of the puddle. Move slowly and methodically, gauging your forward movement to make sure it is steady and paced. Imagine a thick coin is able to be placed between the tip of the Tungsten and the weld puddle. As your skill progresses, you will want to add filler wire to your practice. The angle created between the filler rod should be about 90 degrees. In between the filler rod and the torch, your head should be placed so that you can clearly see the arc. Feed the filler rod into the front edge of the puddle, being careful not to place the filler on top of the Tungsten, or touch it in any way. If you dip the tungsten into the filler rod or into the puddle, you must stop and re-grind it or the arc will become unstable. Feed the filler in regular, timed dips as the puddle

Basic TIG Operation

forms. If you need, count as you time your dips until you can do it without thinking. As you proceed to dip your rod into the edge of the puddle, keep the rod close to the puddle, within the gas cone. If the filler metal starts to melt before you dip, you have it too close, or you have the rod inclined too much so that heat is being directed too far in front of the puddle. As you add the filler, be sure to pause momentarily with the forward travel of the torch. If desired, a tiny back step motion may be used to improve weld appearance. There are other ways to add filler and to create a sound weld. You can keep the filler wire in the puddle, with the rod laying in a flatter profile and weld. As the torch moves forward and the rod melts, the filler can be slid, with gentle pressure, into the puddle as needed to fill the weld. This is known as the Lay-Wire technique. Another method of welding has more to do with torch manipulation than it does filler addition, is called walking the cup. The cup is rested on the metal while the torch head is oscillated in a figure 8 pattern. This will require a forehand grip typically, and a good bit of motion of your forearm to accomplish. The filler metal should be moved from side to side to provide an evenly filled puddle under the Tungsten. This method requires much practice and effort, but yields beautiful welds when performed correctly. If you cannot see the puddle or your helmet flashes (auto darkening types), you need to change your settings. Practice feeding the filler wire without actually welding. Manipulating the wire takes practice and concentration at first. The wire should be held so that a flicking motion of two fingers and the thumb can propel the rod forward into the puddle without losing grip on the filler rod. The rod should rest on the two fingers furthest from the thumb, while the index and

middle finger grasp the rod with the thumb propelling it forward. Other rod manipulation variations may be used, but the key is to develop a comfortable, natural movement that is regular and consistent. If feeding difficulty is encountered, there are some feeding devices that reduce the effort to feed the filler wire and smooth out the feeding process. Do not let feeding the filler wire hold up the learning process. There are numerous accounts of welders making home-made jigs or devices that help feed the TIG rod smoothly. One helpful hint is to make sure you have gloves that offer protection without compromising dexterity. With a proper fitting TIG glove, you should be still able to pick the filler wire up from the table top with your fingers.

There are a lot of hurdles to becoming a proficient TIG welder. But if you will practice when you are not tired, and are comfortable in your surroundings, it will help you learn the art a lot faster than if you are practicing when you are too tired, or over-heated.

Section 3

Basic Theory and Function

Note: A TIG lift start should use a nearly seamless motion. Use a light touch and a quick motion for best results.

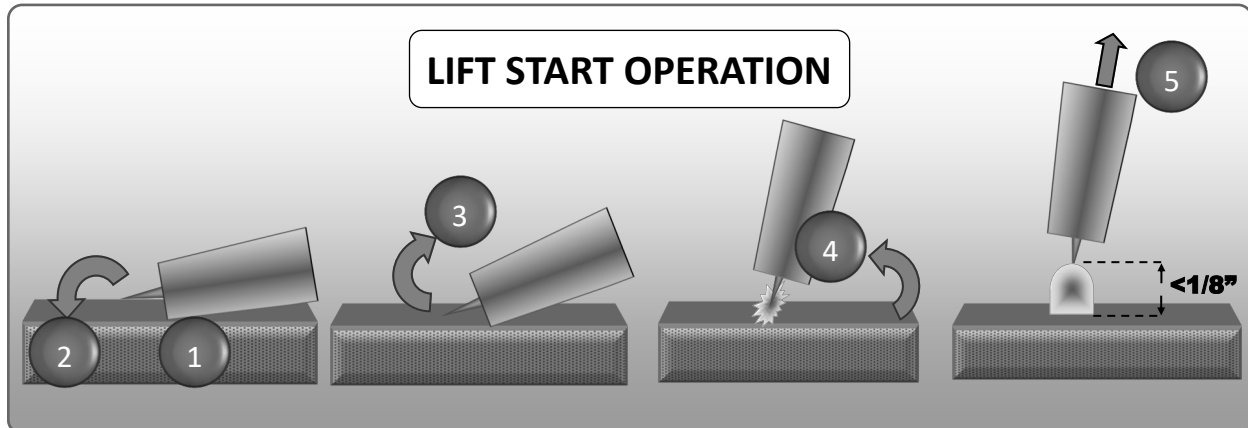

1. Position the edge of the ceramic cup on the metal. Press and hold the torch switch or press the foot pedal. Wait for the Pre-flow to start. (Make sure pre-flow is set for less than .4 seconds or start will be noticeably delayed.)
2. Quickly rotate cup so that the tungsten comes in brief contact (< .5 seconds) with the metal.
3. After contact with the metal, quickly rock the torch back so that the tungsten breaks contact with the metal.
4. An arc should form. As the arc grows, raise the cup up off the metal and slowly rotate the torch into welding position.
5. Leave 1/8" or less gap between the tip of the Tungsten and the metal. Proceed with welding, leaving the torch inclined at a 15° angle.

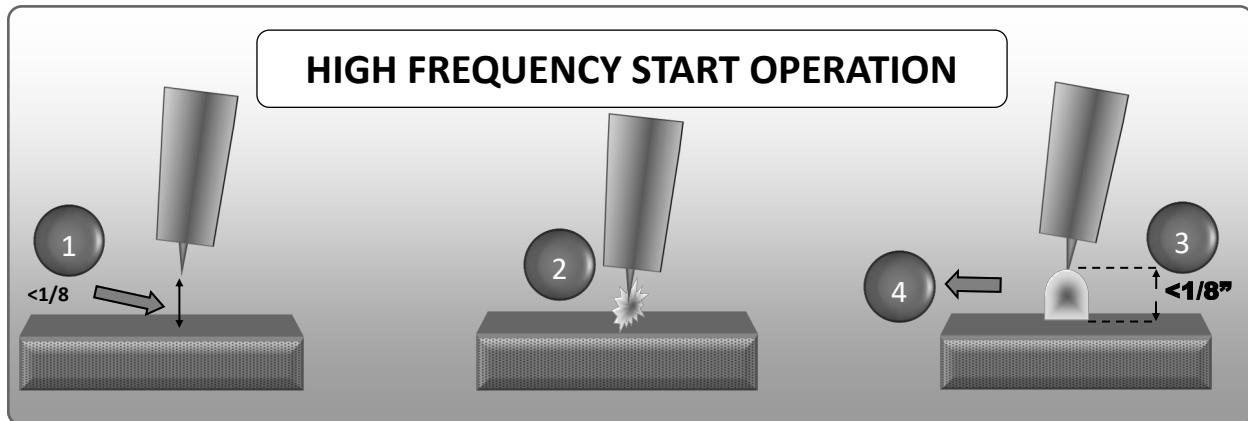

1. Position the point of the sharpened tungsten about 1/8" or less above the metal.
2. Press the torch trigger or press the foot pedal to initiate the arc. The HF arc will be initiated. It may appear briefly as a blue spark.
3. An arc should form, almost immediately after the pre-flow cycle is completed. HF arc initiation will be delayed by the amount of pre-flow time used. If arc does not start after the pre-flow interval, and the HF is creating a spark, then check the work clamp contact with the work piece. Move the tungsten closer to the work. Repeat steps 1 and 2.
4. Leave 1/8" or less gap between the tungsten tip and the metal and proceed with welding, leaving the torch inclined at a 15° angle.

General TIG Arc Starting Steps

1. Turn unit on, allow time for power up cycle to complete its start up process before selecting TIG or Pulse TIG mode.
2. Select either HF or Lift Start TIG with the "HF/Lift Start" selector switch.
3. Plug in the Torch and select "4T" or "2T" mode with the selector switch **OR** plug in foot pedal and select "Pedal".
4. If using the torch switch, select "Upslope" or "Downslope" time by rotating the knob to increase/decrease the ramp up or ramp down time of the amperage.
5. Adjust amps to the desired maximum settings.
6. Start arc as depicted above.
7. If using 2T, continue to hold the torch switch until you are ready to stop welding. Release the switch. The Arc will then cease.
8. If using the foot pedal raise your foot fully off the pedal and arc will stop automatically.
9. If using 4T, release the switch, after arc initiates. Continue to weld without holding the switch down. To stop, press and release the switch again.

TUNGSTEN PREPARATION

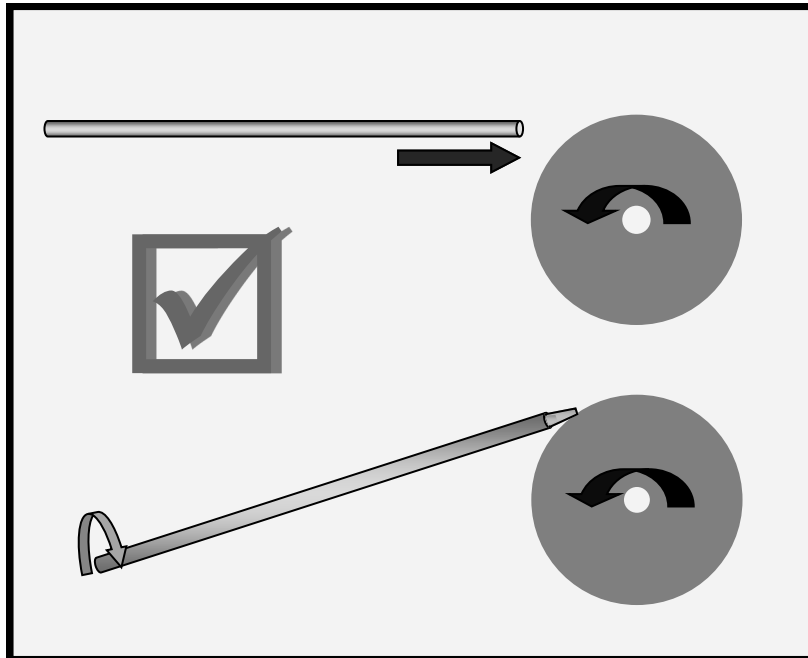

1. Use a dedicated grinding wheel or contamination may result. Do not breath grinding dust! Wear eye protection and gloves.
2. Grip the Tungsten firmly.
3. Grind the Tungsten perpendicular to the wheel face. Allow tungsten to grind slowly without much pressure.
4. Rotate the Tungsten quickly as it is being ground to keep the point even and symmetrical.

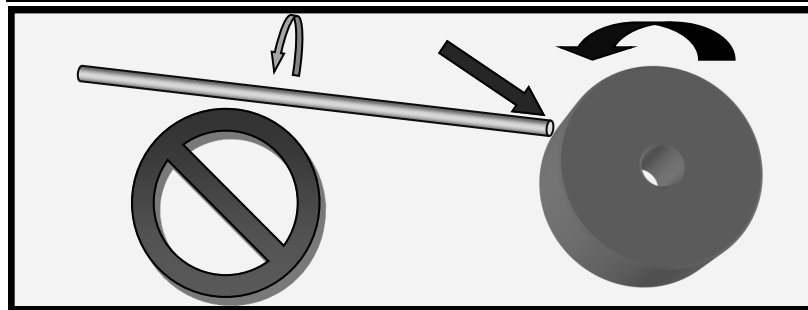

Do not grind the Tungsten parallel to wheel face or an unstable arc will result.

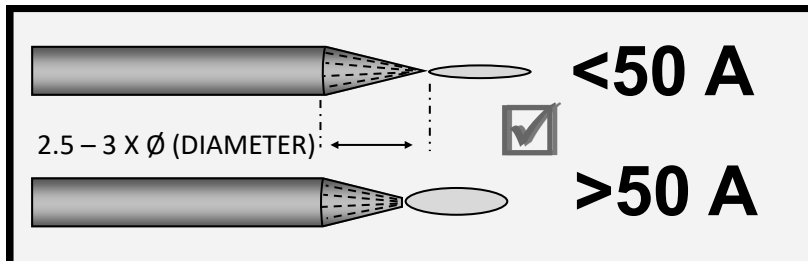

Use a point for low amp use to help control arc. Create a slight truncation on the tip for higher amp use for best arc stability. Grind the tip so that it is 2.5- 3 times longer than the tungsten is wide (Diameter).

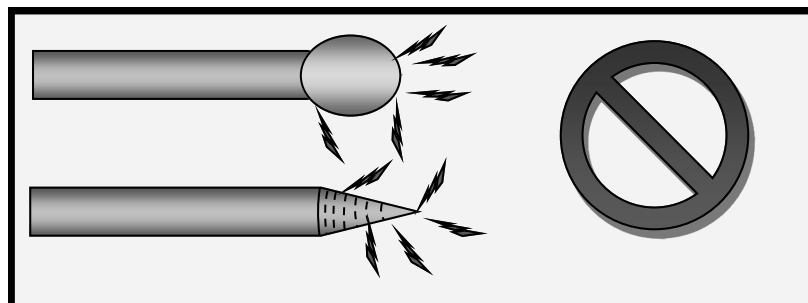

Do not ball the Tungsten while welding, or an erratic arc will result. Make sure that the grinding marks run parallel to the tip. Concentric marks will also cause an erratic arc.

NEVER USE PURE (GREEN) TUNGSTEN IN AN INVERTER WELDER.
SEE FOLLOWING RECOMMENDATIONS ABOUT TUNGSTEN SELECTION FOUND IN THIS MANUAL ON NEXT PAGE.

Pulse TIG Operation

TIG Pulse. The TIG pulse creates two amp values, a high and a low value that cycle back and forth between each other while welding. The upper amperage is called the “TIG Pulse Amps” (sometimes referred to as “Peak” current.) The lower amperage is called “TIG Pulse Base Amps” (sometimes called “background” or “base” current). This creates a situation where penetration can be achieved without overheating the metal, particularly on metals that are prone to structural deterioration or burn through. In effect you are creating an average of amps. Note that this is different from MIG Pulse. MIG pulse pulses between two Volt values, not Amps like TIG Pulse does. This welder features three adjustable parameters concerning the TIG pulse:

1. **Peak and Base Pulse Amps.** Both (Peak) Pulse Amps and Base pulse amps are independently set. **When selecting the Pulse Mode, the welder will bypass the standard TIG Amps LED and will default to the Peak Pulse Amps LED instead.** When you adjust the base Amps, you are actually setting a ratio of Amps. Base amps are expressed as a percentage of TIG Pulse (Peak) Amps. So, when you set base amps, you are only setting it as a percentage, not the actual Amps. As you increase Peak Pulse Amperage, the pulse will maintain the same ratio of Amps you have selected, raising the base Amps automatically. To adjust the base Amps to a desired setting, using an example of 100 Peak Pulse Amps, setting the base Amps to 50% yields a 50 Amp value for the pulse base Amps. The foot pedal will control both Peak and Base Pulse Amps together, according to the percent of

EXAMPLE 1

Peak Pulse Amps: 100 amps,
Base Amps: 50%
Pulse Time On: 50%
DC Pulse Frequency: 1 Hz

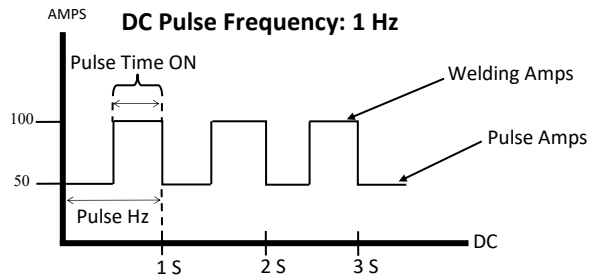

EXAMPLE 2

Peak Pulse Amps: 100 amps
Base Amps: 50%
Pulse Time On : 50%
DC Pulse Frequency: 25Hz

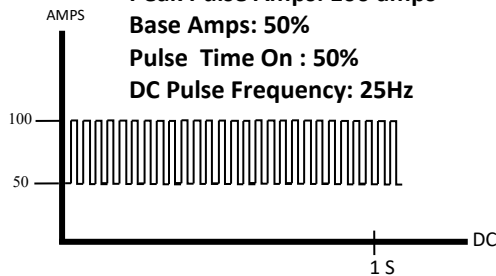

EXAMPLE 3

Peak Pulse Amps: 100 amps
Base Amps: 25%
Pulse Time On: 75%
DC Pulse Frequency: 3 Hz

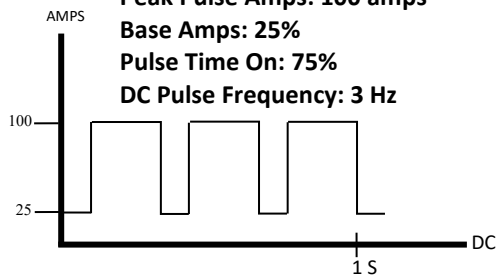

- base Amps selected on the panel.
2. **Pulse Frequency.** Pulse speed or frequency as it is referred to is measured in the standard unit “Hertz.” Simply, it is the number of pulses per second that occur. Pulse frequency controls the arc constriction and also helps with heat management.
3. **Pulse Time On (Balance).** Pulse Balance

Pulse TIG Operation

is the percentage (%) of time that the pulse stays in the TIG (Peak) pulse Amp stage of the cycle. Increasing the Pulse time-on will increase the duration the Peak Amp stage of the cycle which in turn will increase the heat and will increase penetration. Pulse Balance is also known in the industry as duty cycle. For welding purposes the term "Pulse Time On" is used here.

Setting up the pulse is not a process where a fixed adjustment procedure can be assigned or rigidly recommended. Changes to frequency, balance, and time will skew the final result. A slow pulse with a equal 50% pulse time on and somewhere around a 50-75% Pulse Base Amp setting is typically used to help with timing the addition of filler metal to the weld puddle. A higher pulse frequency level that is combined with variations in Pulse Time On and a narrow/wider ratio can be used to prevent burn through and speed up welding on thin materials. It can also help maintain a proper bead profile on a thin edge weld or prevent burn through on extremely thin metal. A fast pulse speed will make fine ripples in the weld while a slow pulse speed will give a much more coarse, but visually appealing result. There are limitless ways to adjust the pulse. Regardless of how you choose to adjust the pulse, always keep in mind, that the basic purpose of the pulse is to average the heat input while maintaining penetration and welding speed.

25 SERIES MIG TORCH

Expanded View

14	IFT0063	SCREW M4X6 UNI 6107	1		21	ICU0004-12	Contact Tip 12/M6x28	1	
13	IHJ0645	Back Box Hole	1		20	ICG6000	SPANNER FOR MIG	1	
12	IFT0897	SPRING FOR CABLE SUPPORT/BLACK	1		19	IFT0160	LABEL ERGO 25AK	1	
11	IHQ0050	INSULATOR TUBE/Ø5 M	0.13m		18	IIC0560-02	Insulated Steel Liner 1.0-1.2 3.1m Red/TORCH	1	
10	ICN0664	COAXIAL CABLE 25mmq. 3m	1		17	IZT0071	Liner Nut	1	
9	IZH0864	Joint With Spring	1		16	ITB0059	Euro Central Adaptor Body/Spring pins	1	
8	IHJ0715	HOUSING FOR HANDLE	1		15	IHJ0070	Gun Plug Nut	1	
7	IFT0874	SCREW D.3x10 UNI9707	3		serial number	drawing number	name	quantity	note
6	IHQ0070	TRIGGER RED	1						
5	ICV0757	MIG HANDLE BLUE/INNO/GRIP	1						
4	ICZ6088	TORCH HEAD 25AK INCLUDING FITTING	1						
3	ICF0061	Gas Diffuser M6/35MM/25AK	1		marking/Places	Revised file NO.	Signature	date	description
2	ICU0004-10	Contact Tip 1.0/M6x28	2		designer		standardization		MIG 25AK Torch 3m With Spring Pins GRIP BLUE HANDLE
1	ICS0078	Gas Nozzle Ø15 25AK	1		drafted		craft		page one
					proofread		approval		one page in total
serial number	drawing number	name	quantity	note	Audit	date	2016-08-15	Shanghai Innotec Co.,Ltd	innotec













NOTE: Over time, pressure on the drive rolls causes metal fragments from the filler wire's surface to find its way to the gun cable liner. If the wire guide is not cleaned, it can gradually clog up and causes wire feed malfunctions. If feeding difficulty is observed, clean the liner in the following manner:

- 1) Remove the welding gun's gas nozzle, contact tip and contact tip's adapter.
- 2) With an air nozzle blow compressed air through the wire guide. Wear eye protection!
- 3) Blow out the wire feed mechanism and reel housing with dry compressed air.
- 4) Reassemble components. Tighten the contact tip and contact tip's adapter with the spanner included to ensure tightness. Do not overtighten any fittings or stripping of the threads may result.

The MIG torch liner may eventually become worn and will need to be replaced. When welding aluminum with the main gun, a Teflon liner must be used, necessitating a liner change. A spool gun is the preferred method to weld Al. To change the liner:

- 1) Remove the securing nut of the liner (#17) which exposes the end of the wire guide.
- 2) Straighten the gun cable and withdraw the liner from the gun.
- 3) Carefully push a new wire guide in to the gun. Make sure that the wire guide travels all the way to the contact tip.
- 4) Make sure the O-ring at the machine-end of the gun is installed
- 5) Tighten the wire guide in place.
- 6) Cut the liner 2mm from the mounting nut and file the sharp edge of the liner.
- 7) Reattach the gun and tighten all parts.
- 8) Re-thread wire.

TORCH CONSUMABLE LIST FOR 25 SERIES MIG TORCH

Item #	Part # I	Ref # T	Ref# B	Description	Size	Image
1		MC0022	145.0124	Nozzle	11.5x57mm	
1	ICS0078	MC0023	145.076	Nozzle Std.	15x57mm	
1		MC0024	145.00042	Nozzle	18x63.5mm	
1		MC0025	145.0169	Spot Nozzle	20x66.5mm	
2		MD0009-06	140.0005	M6 Contact Tip	.023" / .6mm	
2		MD0009-08	140.0051	M6 Contact Tip	.030" / .8mm	
2		MD0009-09	140.0169	M6 Contact Tip	.035" / .9mm	
2	ICU-0004-10	MD0009-10	140.0242	M6 Contact Tip	.040" / 1.0mm	
2		MD0009-12	140.0389	M6 Contact Tip	.045" / 1.2mm	
3	ICF0061	ME0016	142.001	M6 Contact Tip Holder	35mm	
3.1	IFT0809	ME0584	003.0013	Spring (not pictured in diagram)		
4	ICZ-0088	MF0180	12.0001	Torch Neck		
6	IHQ0070		185.0031	Trigger		
18	IIC0560	GM0510	124.006	Liner Std. Red	1.0-1.2mmx 3m	

24 SERIES MIG TORCH

Expanded View

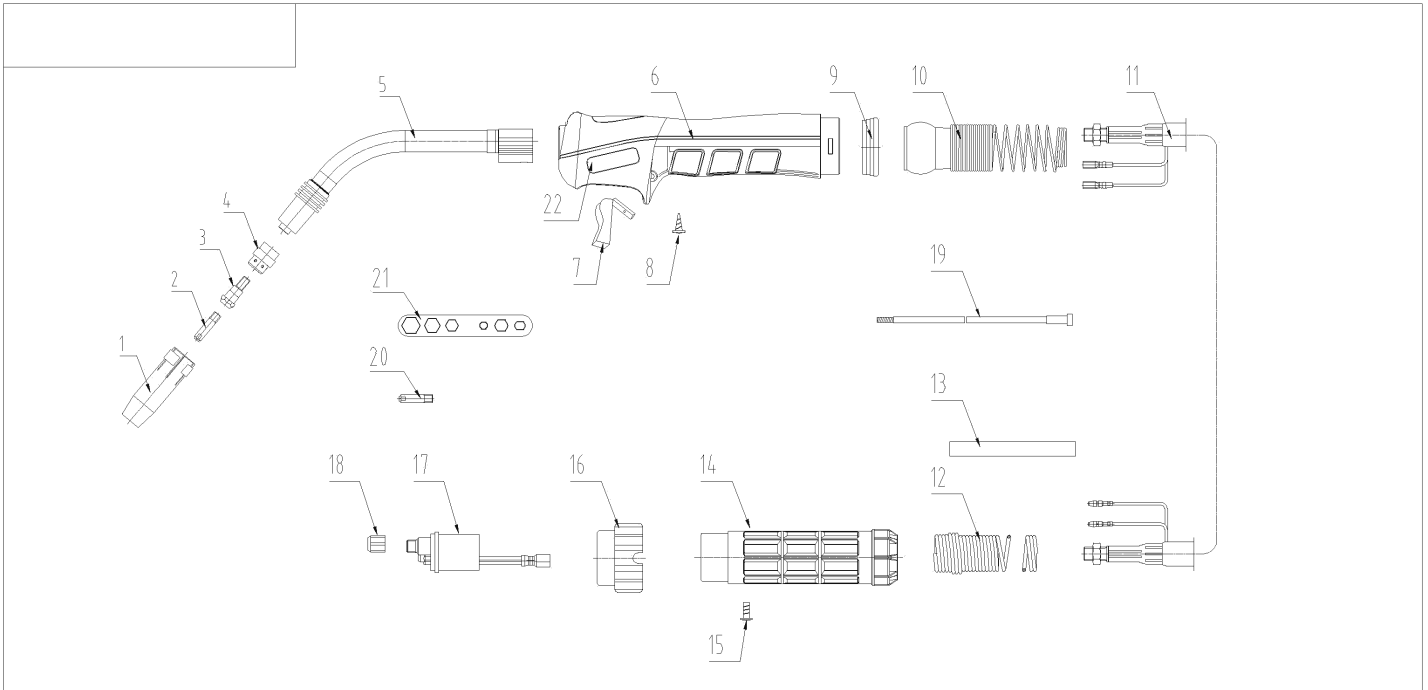

15	IFT0063	SCREW M4X6 UNI 6107	1		22	IFT0104	LABEL ERGO 24KD	1					
14	IHJ0645	Back Box Hole	1		21	ICG6000	SPANNER FOR MIG	1					
13	IHQ0050	INSULATOR TUBE/Ø5 M	0.13m		20	ICU0004-08	Contact Tip 0.8/M6x28	1					
12	IFT0897	SPRING FOR CABLE SUPPORT/BLACK	1		19	IIC0560-02	Insulated Steel Liner 1.0-1.2 31m Red/TORCH	1					
11	ICN0664	COAXIAL CABLE 25mmq 3m	1		18	IZT0071	Liner Nut	1					
10	IZH0864	Joint With Spring	1		17	ITB0059	Euro Central Adaptor Body/Spring pins	1					
9	IHJ0715	HOUSING FOR HANDLE	1		16	IHJ0070	Gun Plug Nut	1					
8	IFT0874	SCREW D.3x10 UNI9707	3										
7	IHQ0070	TRIGGER RED	1		serial number	drawing number	name	quantity	note				
6	ICV0757	MIG HANDLE BLUE/INNO/GRIP	1				ICT2698-26		range of tolerance				
5	ICZ0630	Torch Head 24KD	1					a<6	6<a<30	30<a<120	a>120		
4	ICF0539	White Ceramic Gas Diffuser 24KD	1					±0.1	±0.2	±0.3	±0.5		
3	ICU0683	Contact Tip Holder 24KD M6 26mm	1		markingPlaces	Revised file NO	Signature	date	description	reference number	material	weight(g)	edition
2	ICU0004-10	Contact Tip 1.0/M6x28	2		designer	standordization			MIG 24KD Torch 3m With Spring Pins GRIP/INNO/BLUE HANDLE				A
1	ICS0806	Gas Nozzle Ø12.5 24KD	1		drafted	craft				page one	one page in total		
serial number	drawing number	name	quantity	note	proofread	approval			Shanghai Innotec Co.,Ltd				
					Audit	date	2016-08-15						

NOTE: Some components may appear slightly different as design/supplier changes are made from time to time. At time of publication, the standard MIG gun provided with Power MTS is commonly known as the 24 series. Some units may use a 25 series. To determine the series when purchasing parts, the 24 has cooling rings on the gun neck next to the nozzle, and the copper colored nozzle is split and simply slides on. The 25 series nozzle is usually chrome plated. This torch may be supplied by Binzel®, Trafimet®, or other similar manufacturer. The Innotec® listed above is currently the default supplier of the 36 series. Everlast is not the torch manufacturer, but equips the PowerMTS units with some of the most proven torches in history. Numerous manufacturers all over the world use variations of these torches. The 24 and 25 Series consumables and most parts interchange from brand to brand within torches of the same series number (except torch handle design and trigger). The widely used Euro-connector on the MIG torch also ensures that the customer can fit and install almost any other type MIG torch if they desire, since most manufacturers offer torches with a Euro connector as an option.

TORCH CONSUMABLE LIST FOR 24 SERIES MIG TORCH

Item #	Part # I	Ref # T	Ref# B	Description	Size	Image
1		MCO300	145.0062	Nozzle	17x63.5mm	
1	ICS086	MC0301	145.0080	Nozzle Std.	12.5x63.5mm	
1		MC0302	145.0128	Nozzle	10x63.5mm	
1		MC0303	145.0174	Spot Nozzle	17x68mm	
2		MD0008-06	140.0008	M6 Contact Tip	.023" / .6mm	
2		MD0008-08	140.0059	M6 Contact Tip	.030" / .8mm	
2		MD0008-09	140.0177	M6 Contact Tip	.035" / .9mm	
2	ICU-0004-10	MD0008-10	140.0253	M6 Contact Tip	.040" / 1.0mm	
2		MD0008-12	140.0387	M6 Contact Tip	.045" / 1.2mm	
3	ICU-00683	MD0138-00	142.003	M6 Contact Tip Holder	26mm	
4	ICF-0539	ME0584	012.0183	Gas Diffuser Ceramic	20mm	
5	ICZ-0630	MF0180	12.0001	Torch Neck		
7	IHQ0070		185.0031	Trigger		
19	IC0-560-02	GM0510-2	124.0025	Liner	.8-1.2mm	

featuring a 25 series torch. This torch may be supplied by Binzel®, Trafimet®, Innotec® or other similar manufacturer. However the consumables and many parts for series 24 torches generally interchange from brand to brand except the torch handle design and trigger. The widely used Euro-connector on the MIG torch also ensures that the customer can fit and install almost any other type MIG torch since most manufacturers offer torches with a Euro connector as an option. This list is provided as a general cross reference and does not guarantee that every variation or type is directly available from Everlast. In the left column, are the OEM part numbers. Trafimet® and Binzel® part numbers are listed as a reference where similar or interchangeable. You can also find the list of stocked consumables for the Everlast website for the 24 and 25 series.

EXPANDED VIEW OF TIG TORCH

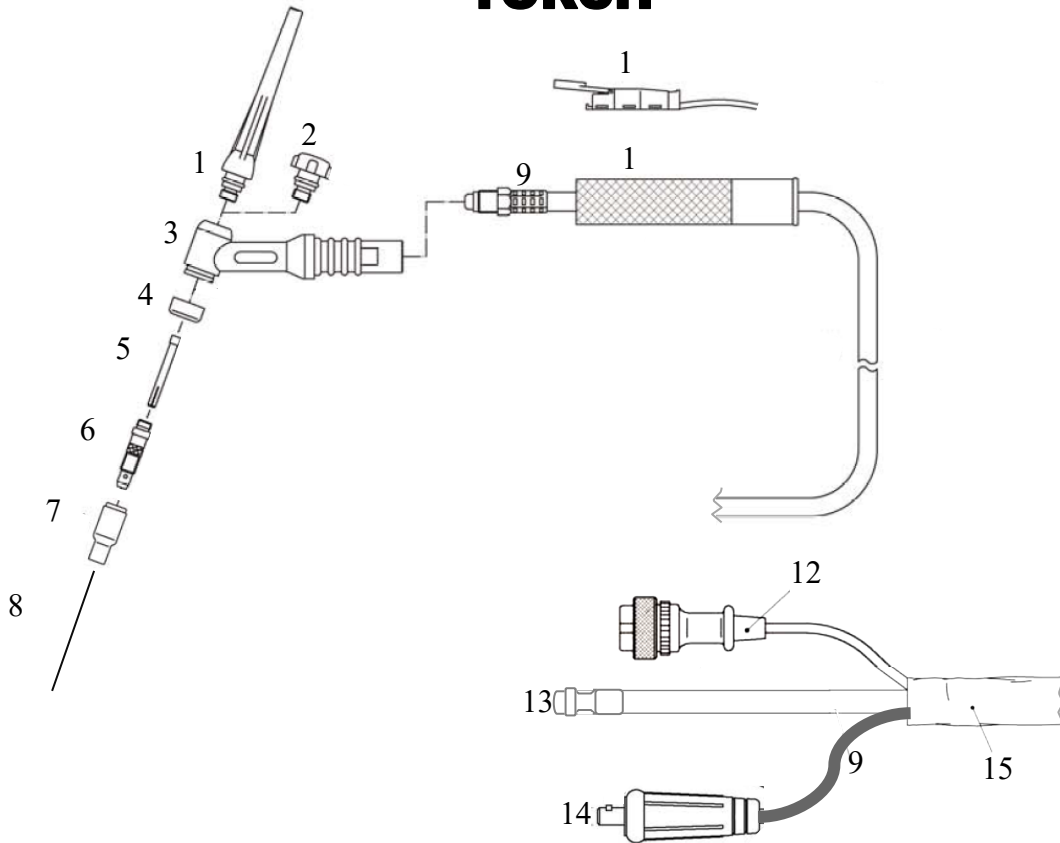

NO.	PARTS FOR 17/26 Series Torch (STYLE MAY VARY)	QTY
1	Long Back Cap with O-Ring	1
2	Short Back Cap	Opt.
3	Torch Head	1
4	Insulator	1
5	Collet 1/16 or 3/32	1
6	Collet Holder	1
7	Ceramic Cup #5,6, or 7	1
8	Tungsten (customer supplied)	0
9	Torch Cable	1
10	Torch Handle	1
11	Torch Switch (1
12	Torch Switch Connector	1
13	9mm (1/8") b quick connect coupling (male)	1
14	Power Connector DINSE 35	1
15	Protective Cover	1

Section 4

Troubleshooting Guide

NO.	Trouble		Possible Cause	Solution
1	Unit is switched on, but the power light isn't on		Switch damaged.	Replace.
			Unit Fuse damaged.	Replace.
			Power breaker tripped.	Reset.
2	After welding machine is over-heating and the fan does not work		Fan damaged.	Check fan housing and fan. Replace if necessary.
			Fan power connector is loose.	Tighten wires, check for dislodged connectors.
3	When torch switch is pressed, no gas Flows		No gas in the gas cylinder.	Replace.
			Gas pipe leaks gas.	Resolve .
			Gas solenoid valve damaged.	Check and clean/replace.
			Torch switch damaged.	Repair or Replace.
4	Wire-feeder does not work	Wire reel does not turn	Motor damaged/Fuse blown.	Check and Replace.
		Control circuit damaged.	Check the board.	
	Wire reel turns	The tensioner is loose or wire slips on rollers. Wrong size drive roll. Wire is not mated in drive groove.	Increase tension. Check for proper drive roll size/type. Make sure wire is in groove not riding on top of the drive roller shoulder.	
		The drive roller doesn't fit the diameter of weld wire.	Change roller or wire size to match.	
		Wire Spool is damaged.	Change out wire spool.	
		Gun liner is jammed.	Repair or change it, clear wire from liner/clean liner with compressed air.	
5	No arc, or no output voltage		Contact Tip is jammed because of slag or burn back.	Clean or replace. If with Aluminum, increase tip size to next size.
			Work clamp engaged in wrong connector.	Change polarity.
6	Welding stops and warning light is on, Wire continues feeding but no arc is present.		Control circuit damaged.	Check the circuit.
			Self-protection has engaged.	Check over-voltage, over-current, over-temperature, lower-voltage and over-temperature. Allow unit to cool if over heated. If an OC, use a shorter wire stick out or smaller diameter wire or reduce power settings with large diameter wires. Check power plug for problems. If easily tripped the Resistor value too low. (Contact Everlast if OC is tripping regularly with normal settings.)
7	Welding Voltage/Current is uncontrollable		Potentiometer damaged.	Repair or Replace it.
			Control board damaged.	Check the circuit.
9	Intermittent Arc/ Wandering arc		Work Clamp is not secure or it is damaged. Too windy/breezy.	Check and/or Work Clamp, change position of clamp and attach direct to the work. Move out of wind.
10	Excessive spatter		Voltage too high too high arc force/ Too high wire speed. Too much torch angle. Wrong size nozzle	Lower voltage or increase wire speed. Check torch angle for less than 15° push or pull. Change arc force settings to reduce spatter. Change nozzle size.
11	Weld sooty or oxidized looking		Poor metal prep, poor gas flow, too much torch angle, wrong gas type, windy or breezy. Plugged nozzle	Thoroughly clean metal, check gas flow and reposition gun so gas flow is not creating turbulence. Move indoors if necessary. Reposition the welder so its fan will not blow on the weld area. Clean nozzle.
12	Bird nesting of the wire around the drive roll		Jammed gun liner, wire too soft (aluminum), gun hose is kinked or coiled too tightly. Too much tension / pressure on wire feeder .	Reduce wire feed tension so that drive will slip if it encounters too much resistance Check Gun and liner and replace if necessary. Straighten cable.
13	Wire feeds irregularly		Wrong drive roller or wrong size drive roller, too little tension on wire, wire in wrong groove.	Check and match wire size to groove size, increase tension on drive rollers. Check to make sure the wire is not riding on the shoulder of the drive roller.
14	Wire burns back and seizes in tip		Wrong contact Tip size or too much burn back time set.	Match tip size for wire diameter. Reduce burn back time. If using with aluminum, use tip designed for aluminum or use one size larger tip than the wire.
15	Nozzle arcs to work piece welding		Nozzle plugged with spatter	Check/clean nozzle and use a nozzle dip.
16	In Stick mode will not arc		Cables not connected, inverter issue	Check connections.
17	In Stick mode, the rod sticks		Arc force/Hot Start is set too low, arc striking method is poor, wrong polarity, too low of amperage. Wet welding rods or wrong kind.	Check polarity. Check Hot Start settings. Increase arc force control/Hot Start. Change arc striking method. Increase amperage. Use fresh welding rods when possible.

Section 4

Troubleshooting Guide

NO.	Trouble	Possible Cause	Solution
18	Arc will not start unless lift started.	Points misadjusted, worn or dirty. HF not selected	Check HF point gap. Clean and set to .035" Contact Technical Support for details. Make sure unit is set to HF
19	Tungsten is rapidly consumed.	Inadequate gas flow. Too small of tungsten. Wrong shielding gas. Use only Ar. Using green tungsten. Wrong polarity. Possible contamination of shielding gas from gas supplier	Check gas flow. Check for Leaks throughout system/regulator/tank. Check for 100% Argon. Use red thoriated or any other type besides Green (Pure) or Zirconiated. Put torch in Negative.
	Tungsten is contaminated, arc changes to a green color.	Tungsten is dipping into weld. Too long of stick-out.	Check and adjust stick out to minimum 1/8 inch. Tungsten is melting. Reduce amperage or increase tungsten size. Reduce stick-out to less than 1/4".
	Porosity of the Weld. Discolored weld color. Tungsten is discolored.	Low flow rate of shielding gas. High flow rate of shielding gas. Tungsten stick-out is too far. Too short of post flow period. Wrong TIG cup size. Possible gas leaks internally or externally due to loose fittings. Base metal is contaminated with dirt or grease.	Increase flow rate on regulator. Check for kinks in tubing. Increase post-flow time. Reduce stick-out to less than 1/4". Increase cup size, or use gas lens. Clean metal thoroughly with approved metal cleaner, or use acetone and a rag to clean metal
	Weld quality is poor. Weld is dirty/oxidized, or porous.	Drafty conditions. Unit is located on the workpiece and is blowing gas off due to fan activity. Solenoid is sticking. Too short of pre-flow or post-flow	Eliminate drafts. Move welder. Check if there is sufficient shielding gas left in tank. Check gas flow. Adjust for higher flow of gas. Listen for audible click of gas solenoid. If no click is heard, then contact Everlast Support. Clean weld properly. Increase pre flow or post flow.
	Unstable Arc.	Poorly ground or shaped tungsten. Bad work clamp connection. Metal is indirectly connected through table or other item.	Regrind to proper point. Wrong polarity. Place torch in DC negative (-). Connect work clamp directly to item being welded.
	Other issues.		Contact Everlast support.

Error Codes

Error Code	Meaning	Possible Cause
E01	Over Voltage/Under Voltage	Check Power Source, Correct Wiring.
E02	Over Current	Operating machine on too small of a conductor. Internal machine fault
E04	Over Temperature	Duty Cycle exceeded. Blocked cooling. Fans not operating properly.
E05	Stuck Switch	Gun switch is held too long without attempting to strike an arc.

